



User Guide

CCD-CALYPSO • *CompactPCI*®

3U Advanced Pentium® M CPU Board

Document No. 3946 • Edition 14

2010-09



CCD-CALYPSO

Contents

About this Manual	4
Edition History	4
Related Documents	5
Nomenclature	5
Trade Marks	5
Legal Disclaimer - Liability Exclusion	5
CCD-CALYPSO Features	6
Feature Summary	6
Short Description CCD-CALYPSO	9
Block Diagram CCD-CALYPSO	14
Top View Component Assembly CCD-CALYPSO	15
Rear I/O Transition Module CCT-RIO	16
CCE-PUNK Mezzanine Module	18
Strapping Headers	19
Connectors & Sockets	19
Front Panel Elements	19
Microprocessor	20
Thermal Considerations	21
Main Memory	21
LAN Subsystem	22
Serial ATA Interface (SATA)	22
Enhanced IDE Interface	23
Graphics Subsystem	23
Real-Time Clock	24
Universal Serial Bus (USB)	24
LPC Super-I/O Interface	25
Reset/Watchdog	25
Firmware Hub (Flash BIOS)	26
PG (Power Good) LED	26
HD (Hard Disk Activity) LED	26
GP (General Purpose) LED	26
Hot Swap Detection	26
Power Supply Status (DEG#, FAL#)	27
PXI Trigger Signals	27
Local GPIO Option	27
Rear I/O Options	28
Installing and Replacing Components	29
Before You Begin	29
Installing the Board	30
Removing the Board	31
EMC Recommendations	32
Installing or Replacing the Memory Modules	33
Replacement of the Battery	33
Technical Reference	34
Local PCI Devices	34
Local SMB Devices	35
Hardware Monitor LM87	36

GPIO Usage	37
GPIO Usage ICH6	37
GPIO Usage FWH	39
GPIO Usage SIO	39
Configuration Jumpers	40
Reset Jumper BIOS CMOS RAM Values (JGP)	40
Reset Jumper ICH6 RTC Core (JRTC)	40
Connectors	41
Front Panel Connectors	41
Video Monitor Connector DVI-I	43
Video Monitor Connector VGA	44
USB Connectors	44
Ethernet Connectors	45
Internal Connectors	46
Expansion Interface Header PEXP	47
ATA/IDE Header PIDE	48
PCI Express Expansion Header PPCIE	50
Speaker Header JSPK	52
System Reset Header JRST	52
PLD Programming Header ISPCON	52
Processor Debug Header PITP	53
<i>CompactPCI</i> J1	54
<i>CompactPCI</i> J2	55
Literature	57
Appendix	58
Mechanical Drawings	58

About this Manual

This manual describes the technical aspects of the CCD-CALYPSO, required for installation and system integration. It is intended for the experienced user only.

Edition History

Ed.	Contents/Changes	Author	Date
1	User Manual CCD-CALYPSO, english, initial edition (Text #3946, File: ccd_uge.wpd)	gn	2005-10-28
2	Corrected table of local PCI devices, added section "Hardware Monitor LM87"	gn	2005-12-02
3	Added images CCD-CALYPSO, CCT-RIO	jj	4 January 2006
4	Added chapter "Appendix" containing mechanical drawings	gn	2006-01-19
5	Added image CCD-CALYPSO (top view w/o heatsink) Added image of single slot backplane for SAC/SBC operation	jj	23 March 2006
6	Reworked sections "Reset/Watchdog", "Real-Time Clock", table "GPIO Usage FWH" and table "GPIO Usage ICH6"	gn	2006-05-05
7	Corrected mechanical drawing in chapter "Appendix" (position of PPCIE) Corrected table of expansion interface connector PEXP (pin 40) Updated table "Feature Summary" from latest product info Removed some typos	gn	2006-07-20
8	Added images CCD-CALYPSO w. CCB-BOSSANOVA, C15-DON, CCD-CALYPSO w. C10-CFA Updated table 'Feature Summary' Updated table 'Processors Supported'	jj	23 August 2006
9	Added Performance Score for CCD-2 Added Power Requirements	jj gn	25 September 2006
10	Added +12V connectivity to table of expansion interface connector PEXP (pin 40) and to the table in section "Hardware Monitor LM87". Added photo/section CCE-PUNK, modified illustration 'Front Panel Connectors'	gn jj	2007-02-13
11	Added information regarding Ethernet Jumbo Frame support to table 'Feature Summary'	jj	7 February 2008
12	Added/replaced several photos and illustrations	jj	27 November 2008
13	Table J1 pin D15 - changed to not connected	jj	23 March 2010
14	Corrected section 'Replacement of the Battery'	gn	2010-09-06

Related Documents

For information about the CCA-LAMBADA mezzanine companion board refer to the CCA Technical Information Manual, available at http://www.ekf.com/c/ccpu/cca/cca_tie.pdf.

For information about the CCB-BOSSANOVA mezzanine companion board refer to the CCB Technical Information Manual, available at http://www.ekf.com/c/ccpu/ccb/ccb_tie.pdf.

For information about the CCE-PUNK mezzanine companion board refer to the CCE Technical Information Manual, available at http://www.ekf.com/c/ccpu/cce/cce_tie.pdf.

For information regarding the CCT-RIO rear I/O transition module please read the CCT Technical Information Manual, available at http://www.ekf.com/c/ccpu/ccd/cct_tie.pdf.

For ordering information refer to document CCD-CALYPSO Product Information, available at http://www.ekf.com/c/ccpu/ccd/ccd_pie.pdf.

Nomenclature

Signal names used herein with an attached '#' designate active low lines.

Trade Marks

Some terms used herein are property of their respective owners, e.g.

- ▶ Intel, Pentium, Celeron, Pentium M, Core Duo: ® Intel
- ▶ *CompactPCI*: ® PICMG
- ▶ Windows 2000, Windows XP: ® Microsoft
- ▶ EKF, ekf system: ® EKF

EKF does not claim this list to be complete.

Legal Disclaimer - Liability Exclusion

This manual has been edited as carefully as possible. We apologize for any potential mistake. Information provided herein is designated exclusively to the proficient user (system integrator, engineer). EKF can accept no responsibility for any damage caused by the use of this manual.

CCD-CALYPSO Features

Feature Summary

Feature Summary CCD-CALYPSO	
Form Factor	Single size <i>CompactPCI</i> style Eurocard (160x100mm ²), front panel width 4HP (20.3mm)
Processor	Designed for Intel® Pentium® M Micro FC-BGA 479 processors (90nm Dothan), maximum junction temperature 100°C <ul style="list-style-type: none"> ▶ CCD-2: 1.0GHz ULV Celeron® M (Dothan 373), 400MHz FSB, 512KB L2 cache, 5W ▶ CCD-3: 1.4GHz LV Pentium® M (Dothan 738), 400MHz FSB, 2MB L2 cache, 10W ▶ CCD-6: 2.0GHz Pentium® M (Dothan 760), 533MHz FSB, 2MB L2 cache, 27W
Chipset	Intel® i915GM chipset (Alviso) consisting of: <ul style="list-style-type: none"> ▶ 82915GM Graphics/Memory Controller Hub (GMCH) with Intel® Graphics Media Accelerator (GMA) 900 ▶ 82801FB I/O Controller Hub (ICH6) ▶ 82802 Compatible Firmware Hub (FWH)
Memory	Dual 200-pin SO-DIMM socket, DDR2 533 SDRAM, 2 x 1GB maximum, single or dual channel mode
Video	Analog monitor and digital flat-panel display support by DVI-I connector (front panel), up to 2048x1536 pixel 16M colours @75Hz refresh rate (analog), up to 1600 x 1200 pixel 16M colours @60Hz (digital), incorporates PanelLink Digital technology (Silicon Image). <ul style="list-style-type: none"> ▶ Front panel option: D-Sub (female HD15) VGA connector available, replaces DVI-I connector ▶ Rear I/O option: Analog video across J2/P2 CCT-RIO rear I/O transition module) ▶ Dual screen capable 2 x 1600 x 1200 pixel (one display attached to the front panel, the other to the back panel, or both to the front panel by means of a DVI-I splitter cable)
USB	All ports over-current protected, data transfer rate of up to 480Mbps, conforming to USB2.0: <ul style="list-style-type: none"> ▶ 2 x USB type A connector (front panel) ▶ 3 x USB ports J2/P2 Rear I/O option (CCT-RIO rear I/O transition module) ▶ 2 x USB ports expansion interface option (CCA-LAMBADA / CCB-BOSSANOVA / CCE-PUNK mezzanine companion board) ▶ USB Flash drive module C15-DON option (USB stick on-board module)
Ethernet	<ul style="list-style-type: none"> • Dual 10/100/1000Mbps Gigabit Ethernet controller • Accessible via RJ45 jacks from the front panel • Option 1 x GbE across J2/P2 with attached CCT-RIO rear I/O transition module • Jumbo Frame support up to 9KB
Mezzanine I/O	<ul style="list-style-type: none"> • On-board LPC/USB/AC97 Super-I/O, USB and audio expansion interface connector • ATA/IDE expansion connector • High Speed PCI Express expansion connector • Suitable mezzanine companion boards available: <ul style="list-style-type: none"> • C10-CFA: CompactFlash adapter module • C13-RD: Front Panel CF Card Slot • C15-DON: On-board USB stick module (USB Flash disk) • C17-CFA: Bottom mount CF Card Adapter • C23-SATA: PCIe to SATA controller, USB SSD, COM ports • C30-PATA: 1.8-inch HDD/SSD module • CCA-LAMBADA: Front panel COM, USB, AC'97 audio, PS/2 keyboard/mouse, on board hard disk drive 1.8-inch or 2.5-inch • CCB-BOSSANOVA: Front panel up to 2 x COM, up to 2 x USB, PS/2 keyboard/mouse, on board hard disk drive 1.8-inch or 2.5-inch • CCE-PUNK: Front panel 2 x COM, 2 x USB, 2 x 1394a FireWire, on board hard disk drive 1.8-inch or 2.5-inch

Feature Summary CCD-CALYPSO

PATA (IDE)	<ul style="list-style-type: none"> • Ultra ATA/100 connector, handover to CCA-LAMBADA / CCB-BOSSANOVA / CCE-PUNK mezzanine expansion board with optional on-board 2.5-inch hard disk drive or external device • CompactFlash socket C10-CFA supplied for a CF memory card • Option front panel CompactFlash slot C13-RD • Option 1.8-inch on-board HDD/SSD module C30-PATA, replaces CompactFlash facility 				
SATA	Triple-channel Serial ATA I/F available for J2/P2 rear I/O option, suitable rear I/O transition module CCT-RIO (2 x system internal SATA, 1 x eSATA for attachment of external devices)				
<i>CompactPCI</i>	ICH6 integrated 32-bit PCI bridge, 133MBps CPCI master				
PCI Express	1-Lane PCIe connector (option) for CCE-PUNK and future mezzanine companion boards				
J2/P2 Rear I/O	<ul style="list-style-type: none"> • 3 x Serial ATA (SATA), 2 x system internal SATA connectors, 1 x external eSATA connector • 1 x GB Ethernet (switched by BIOS between front panel I/O and rear I/O) • 3 x USB • VGA Analog Video, or GPIO • Keyboard, Mouse • COM1 (TTL Level) • Suitable rear I/O transition module CCT-RIO available 				
BIOS	<ul style="list-style-type: none"> • Phoenix BIOS with EKF enhancements • 8Mbit Flash memory • Updates available from website ekf.com 				
Drivers (All Major OS)	<ul style="list-style-type: none"> ▶ Intel graphics drivers ▶ Intel networking drivers 				
Typical Power Requirements		+3.3V +0.17V/-0.1V		+5V +0.25V/-0.15V	
	Board	MaxPower LFM/HFM ¹⁾	WinXP Idle LFM/HFM ¹⁾	MaxPower LFM/HFM ¹⁾	WinXP Idle LFM/HFM ¹⁾
	CCD-2-CALYPSO	2.7A ²⁾	2.2A ²⁾	1.2A ²⁾	0.5A ²⁾
	CCD-3-CALYPSO	2.9A/2.9A	2.2A/2.2A	1.2A/2.4A	0.7A/0.9A
CCD-6-CALYPSO	3.0A/3.3A	2.3A/2.3A	1.2A/5.2A	0.7A/1.6A	

Feature Summary CCD-CALYPSO

Thermal Conditions Environmental Conditions	<ul style="list-style-type: none"> ▶ Operating temperature: 0°C ... +70°C (CPU dependent) ▶ Storage temperature: -40°C ... +85°C, max. gradient 5°C/min ▶ Humidity 5% ... 95% RH non condensing ▶ Altitude -300m ... +3000m ▶ Shock 15g 0.33ms, 6g 6ms ▶ Vibration 1g 5-2000Hz 												
EC Regulations	<ul style="list-style-type: none"> ▶ EN55022, EN55024, EN60950-1 (UL60950-1/IEC60950-1) ▶ 2002/95/EC (RoHS) 												
MTBF	tbd												
Performance Rating	<table border="1" style="width: 100%; border-collapse: collapse;"> <thead> <tr> <th style="width: 25%;">Board</th> <th style="width: 50%;">Processor</th> <th style="width: 25%;">CPU/MEM Score</th> </tr> </thead> <tbody> <tr> <td>CCD-2-CALYPSO</td> <td>1.0GHz ULV Celeron® M (Dothan 373)</td> <td>4735/8642</td> </tr> <tr> <td>CCD-3-CALYPSO</td> <td>1.4GHz LV Pentium® M (Dothan 738)</td> <td>tbd</td> </tr> <tr> <td>CCD-6-CALYPSO</td> <td>2.0GHz Pentium® M (Dothan 760)</td> <td>tbd</td> </tr> </tbody> </table>	Board	Processor	CPU/MEM Score	CCD-2-CALYPSO	1.0GHz ULV Celeron® M (Dothan 373)	4735/8642	CCD-3-CALYPSO	1.4GHz LV Pentium® M (Dothan 738)	tbd	CCD-6-CALYPSO	2.0GHz Pentium® M (Dothan 760)	tbd
Board	Processor	CPU/MEM Score											
CCD-2-CALYPSO	1.0GHz ULV Celeron® M (Dothan 373)	4735/8642											
CCD-3-CALYPSO	1.4GHz LV Pentium® M (Dothan 738)	tbd											
CCD-6-CALYPSO	2.0GHz Pentium® M (Dothan 760)	tbd											
Measured with PCMark2002 under Windows XP, 1GB DDR2 533													

¹⁾ Intel SpeedStep® Frequency Modes. LFM: Low Frequency Mode, HFM: High Frequency Mode

²⁾ The ULV Celeron® M processor on CCD-2 does not support Intel SpeedStep®, (alwaysHigh Frequency Mode)

Subject to technical changes

Short Description CCD-CALYPSO

*Scalable from the ULV Celeron® M processor up to the 2.0GHz Pentium® M, and provided with 2GB dual channel capable DDR2 RAM, the CCD-CALYPSO is a versatile 4HP/3U (single size Eurocard) **CompactPCI**® CPU board, designed especially for systems which require high performance at low power consumption.*

The chipset is based on PCI Express technology and has a powerful dual-screen integrated graphics accelerator. The DVI-I video interface allows for simultaneous attachment of both, advanced (digital) and legacy (analog) flat panel displays and CRT monitors (D-SUB connector optionally).

The CCD-CALYPSO is equipped with two independent PCIe Gigabit Ethernet controllers for high speed communication.

Seven USB 2.0 ports are provided for attachment of peripheral devices. In addition, an on-board CF socket accommodates either a CompactFlash memory card or Microdrive®. As an alternate, an 1.8-inch hard disk module is available as on-board mass-storage device (option).

A local expansion interface connector may be used to directly attach a mezzanine companion board for audio- and legacy support, which can carry in addition a 2.5-inch IDE hard disk drive.

As an option, a rear I/O transition module is available to the CCD-CALYPSO, which e.g. provides the Serial ATA connectors (2 x SATA, 1 x eSATA).

Benefits of the CCD-CALYPSO

- ▶ Pentium® M 2GHz (FSB 533MHz) CompactPCI CPU
- ▶ 2 x 1GB DDR2 Memory (Dual Channel Mode Capable)
- ▶ Dual-Screen Graphics Controller
- ▶ Dual Gigabit Ethernet Controllers
- ▶ Triple SATA I/F
- ▶ Seven USB 2.0 channels
- ▶ On-Board CompactFlash or on-Board 1.8-Inch Hard Disk
- ▶ PCI Express Chipset i915GM Alviso
- ▶ Mezzanine Expansion Board and Rear I/O Transition Module Options
- ▶ RoHS compliant



CCD-CALYPSO with Optimized Pin Heatsink for Improved Horizontal Airflow (Option)

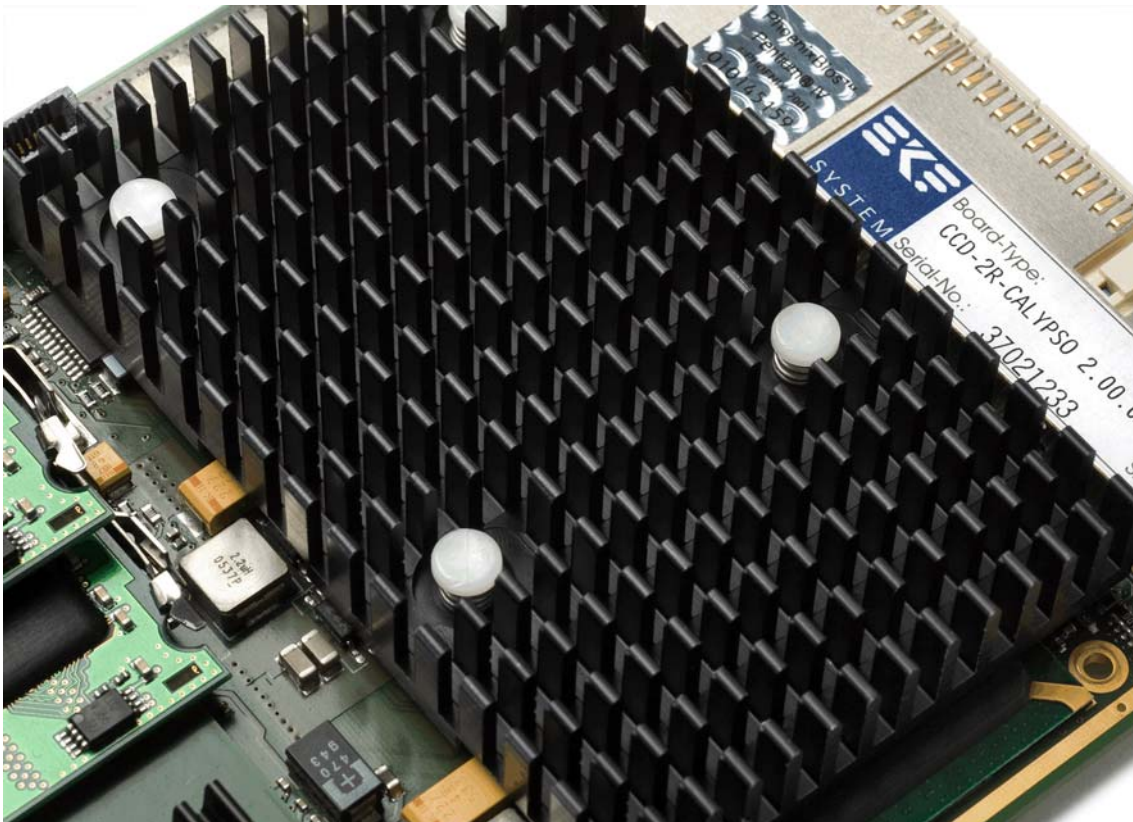

Optimized Heatsink for Improved Horizontal Airflow (Option)



CCD-CALYPSO w. C10-CFA CompactFlash Adapter Module

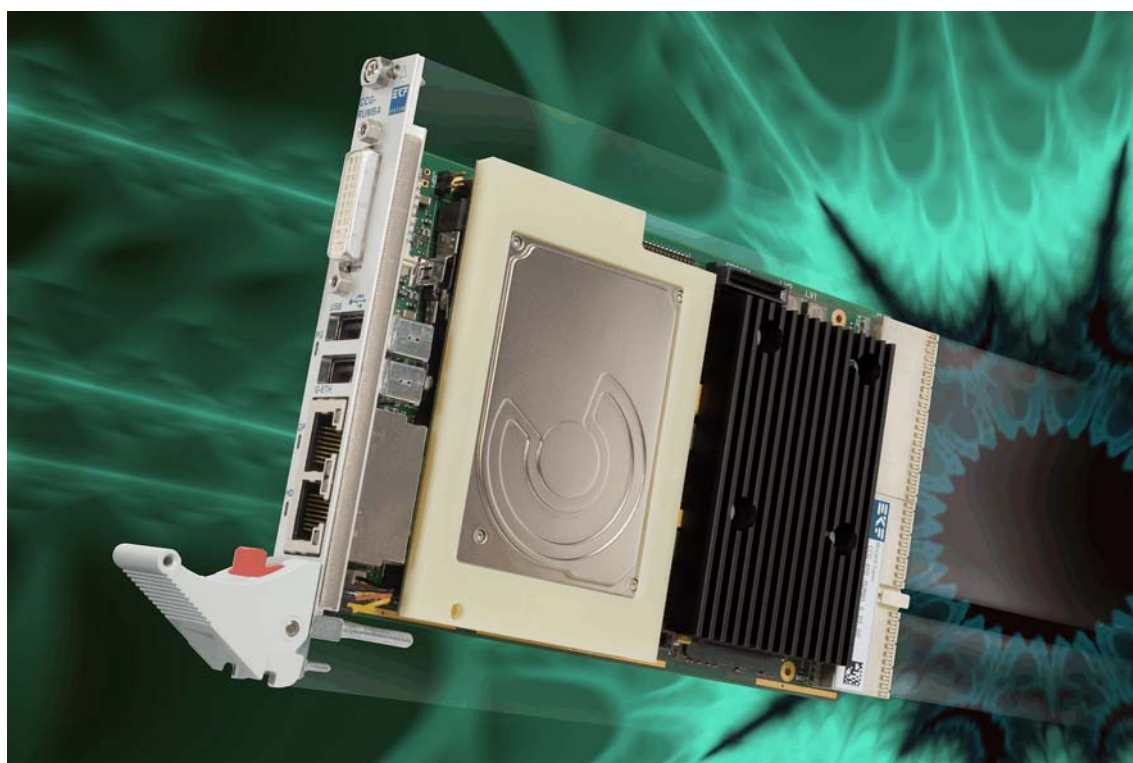

CCD-CALYPSO w. C30-PATA 1.8-Inch HDD/SSD (Picture Similar)



C10-CFA (Top Mount CF Card Adapter)

The CCD-CALYPSO comes with a CompactFlash adapter module (C10-CFA), which is suitable to hold a silicon memory CF card, operated in 'True IDE Mode' similar to a hard disk. If the CCD-CALYPSO is accompanied by a mezzanine expansion module such as the CCA-LAMBADA or CCB-BOSSANOVA, the position of the C10-CFA CompactFlash adapter module changes to the mezzanine card.

Optionally an on-board 1.8-inch drive (HDD or SSD) module is available (C30-PATA). When ordered, it replaces the CompactFlash adapter module (please request for a special solution which allows to use both the CF slot and the 1.8-inch drive simultaneously). The C30-PATA allows to maintain the 4HP envelope and can be combined with additional expansion side boards on the CCD-CALYPSO.

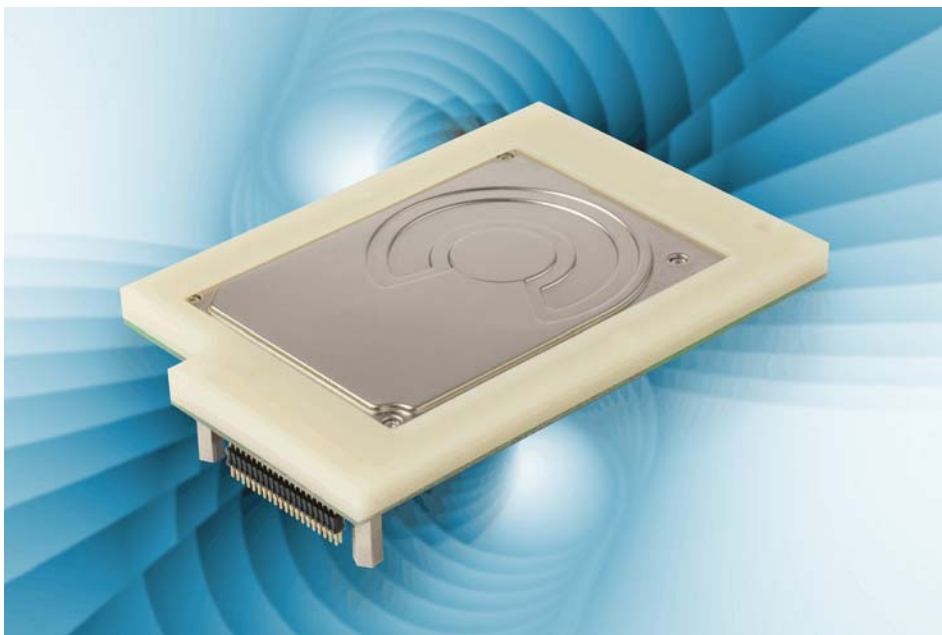

C30-PATA Option



CCD-CALYPSO w. CCB-BOSSANOVA Mezzanine Companion Board & 2.5-Inch HD



USB Flash Drive Option C15

Block Diagram CCD-CALYPSO

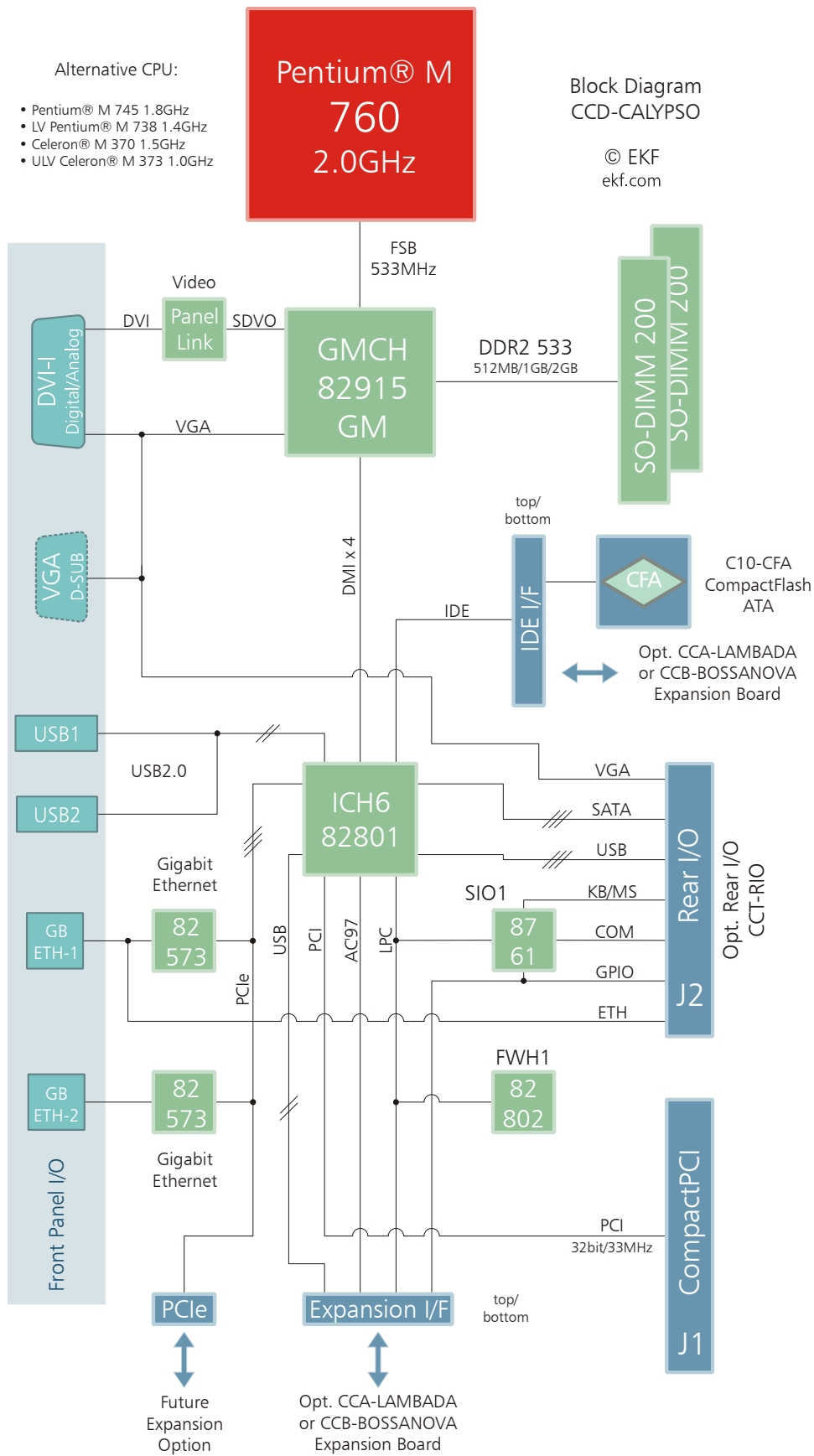

Top View Component Assembly CCD-CALYPSO

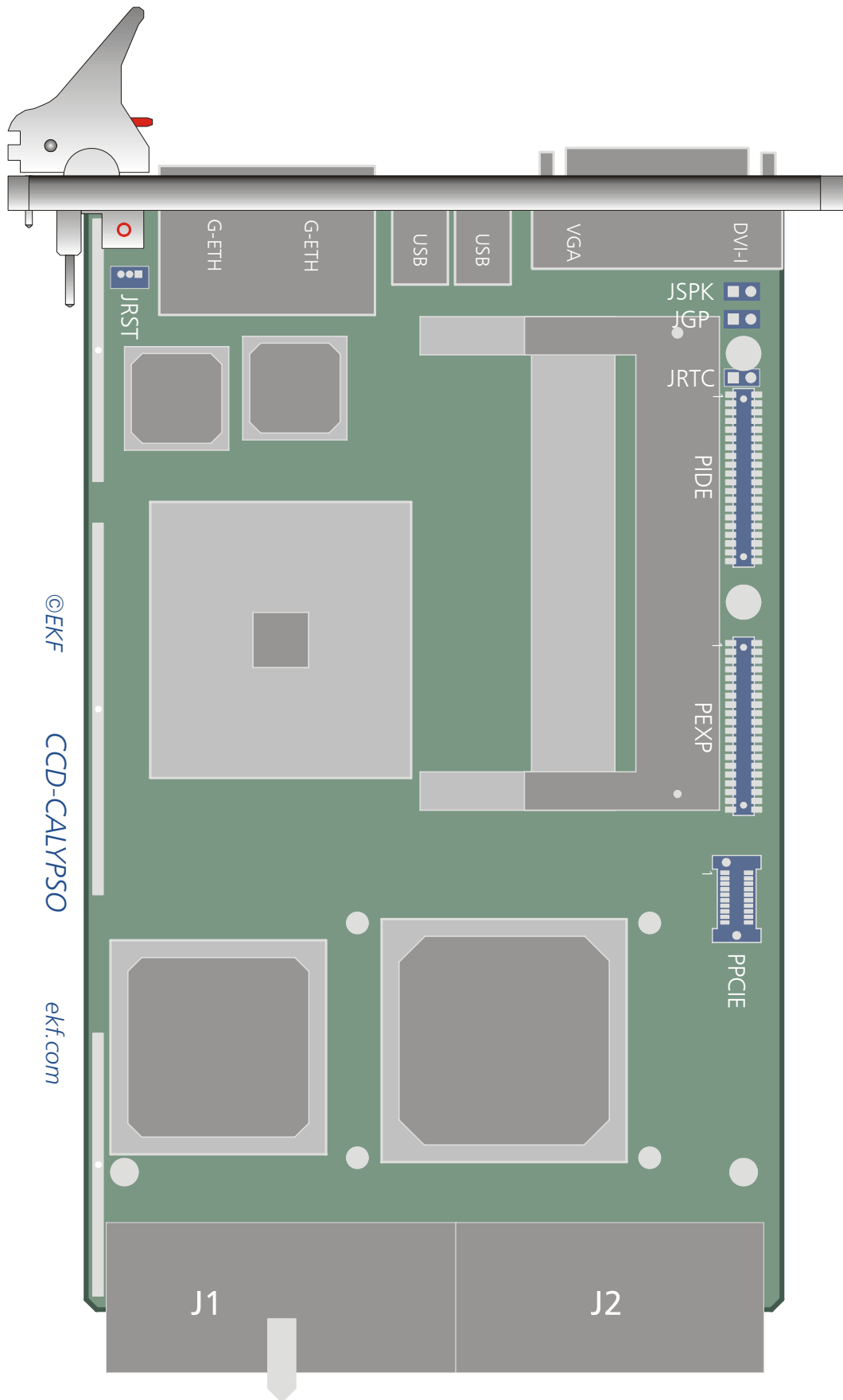

Rear I/O Transition Module CCT-RIO

Available as a rear I/O expansion board to the CCD-CALYPSO CPU card, the CCT-RIO is provided with several I/O port connectors, to be used either in addition to the CCD front panel connectors or alternatively. Being mainly a passive rear I/O transition module, groups of signals from the CCD-CALYPSO CPU board are passed across the CompactPCI J2/P2 connector to the CCT-RIO. Some of the data lines are available locally on the CCT board for system internal wiring only, while other connectors such as VGA-Video and Gigabit Ethernet are mounted into the back panel for external use. USB and SATA (eSATA) channels are provided both on-board and externally.

Typically the CCT-RIO is equipped with a 4-HP rear panel (20.3mm width). As a custom specific option, an 8-HP panel is available with additional connectors. Utilization of the CCT-RIO transition module adds a level of I/O functionality that is not available with the CCD-CALYPSO CPU board alone. Further on, swapping the CPU card is simplified by means of rear I/O, which is important for efficient system maintenance (MTTR).

For technical details please refer to the 'CCT-RIO Technical Information Manual', available at www.ekf.com/c/ccpu/ccd/cct_tie.pdf.



CCT-RIO (Shown with on-Board USB Stick)

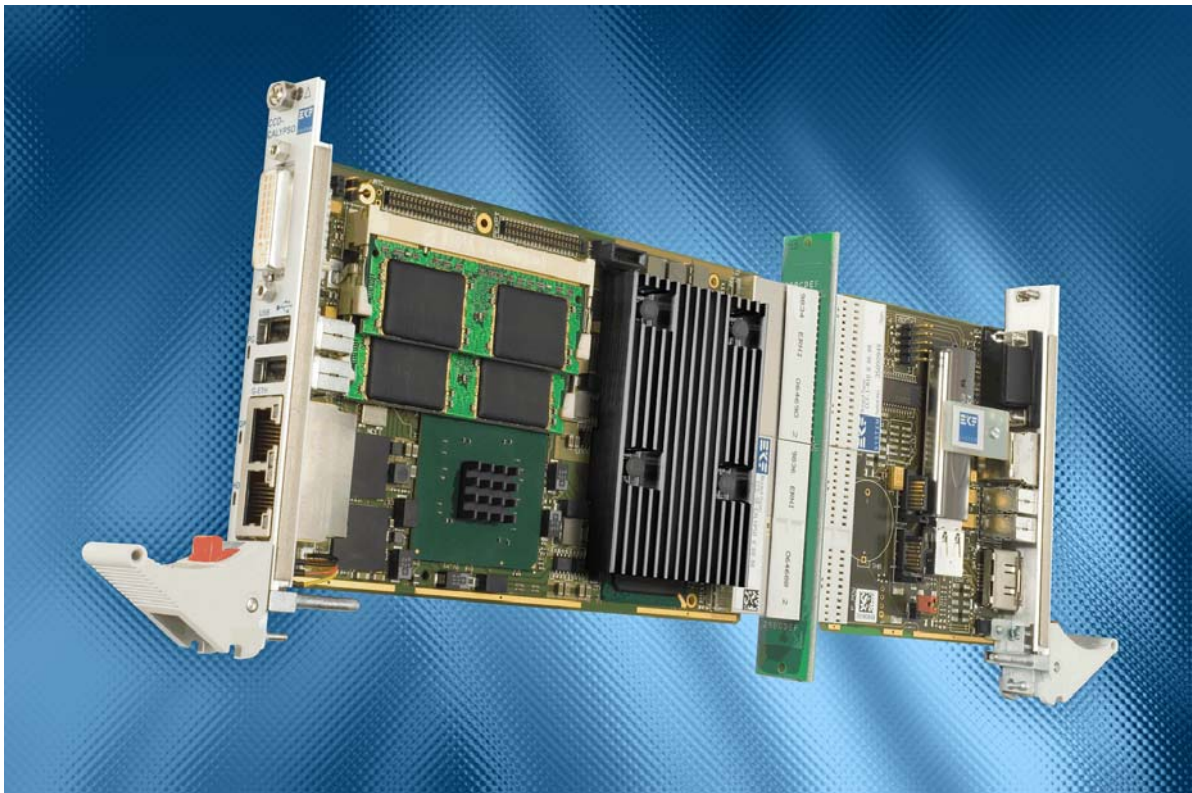
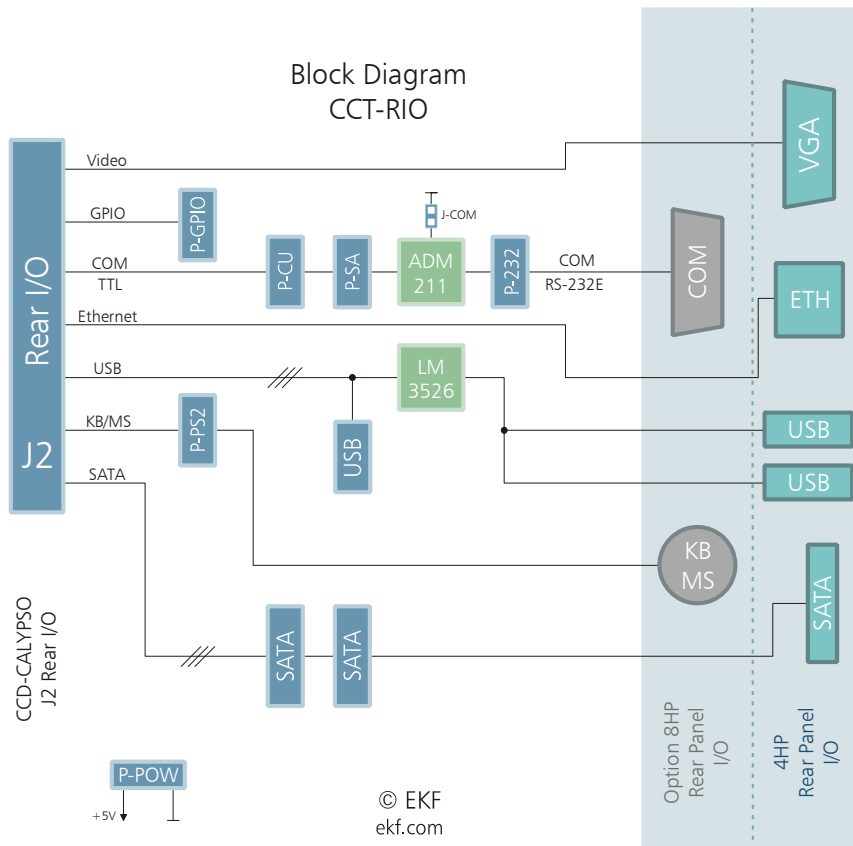

CCD-CALYPSO with CCT-RIO

CCE-PUNK Mezzanine Module

Available as a mezzanine companion board to the CCD-CALYPSO CPU card, the CCE-PUNK is provided with high-speed communication channels such as FireWire™ and USB, and common legacy I/O ports as well. Interconnection between the CCE-PUNK I/O module and the CPU carrier board is achieved by several expansion connectors, which comprise the PCIe (PCI Express), LPC (Low Pin Count) and ATA/IDE interfaces.

As an option, the CCE-PUNK is available with a rugged on-board 2.5-inch hard disk drive (1.8-inch as a mezzanine module).

The CCE-PUNK will be attached on top of the CPU board, and shares its front panel typically with the host CPU carrier board (8HP front panel width in total).



CCD-CALYPSO CPU Board with CCE-PUNK Mezzanine Companion Module

Strapping Headers

ISPCON	PLD Programming Connector, not stuffed
JGP	Jumper to Reset BIOS CMOS RAM Values
JRST	Jumper to Reset Board
JRTC	Jumper to Reset RTC Core of ICH6, not stuffed
JSPK	Speaker Connector

Connectors & Sockets

J1/J2	<i>CompactPCI</i> Bus 32-bit, 33MHz, PXI, Rear I/O
PEXPT PEXPB	Expansion Interface Connector (LPC Interface (2 nd Super-I/O, 2 nd FWH), USB Interfaces, AC'97 Interface, GPIOs), available either from top (T) or bottom (B) of the board
PIDET PIDEB	Ultra ATA/100 IDE Port (Interface to CompactFlash ATA Socket on C10-CFA), available either from top (T) or bottom (B) of the board
PITP	CPU Debug Port
PPCIE	PCI Express Expansion Interface Connector
SODIMM1 SODIMM2	200-pin DDR2 Memory Module SDRAM PC2-3200/4200 (DDR400/533) Sockets

Front Panel Elements

Ethernet (G-ETH)	Dual 1000Base-TX/100Base-TX/10Base-T, RJ-45 Receptacles with integrated indicator LEDs
Graphics (DVI-I)	DVI-I Integrated (digital & analog) Receptacle, suitable for DVI digital flat panel displays and/or analog monitors
USB1/2	Universal Serial Bus 2.0 self powered root hub, type A receptacle
GP	General Purpose LED
HD	LED indicating any activity on IDE or SATA ports
PG	LED indicating Power Good/Board Healthy

Microprocessor

The CCD-CALYPSO is designed for use with Pentium® M and Celeron® M processors manufactured in 0.09µ technology (Dothan). These includes also the Ultra Low-Voltage (ULV) Celeron® M and the Low-Voltage (LV) Pentium® M processors as listed below. The processors are housed in a Micro FC-BGA package for direct soldering to the PCB, i.e. the CPU chip cannot be removed or changed by the user.

The processors supported by the CCD-CALYPSO are running at FSB clock speeds of 400MHz and 533MHz. The internal Pentium M processor speed is achieved by multiplying the host bus frequency by a variable value. The multiplier is chosen by currently required performance and the actual core temperature. This technology is called Enhanced Intel SpeedStep®.

Power is applied across the *CompactPCI* connectors J1 (3.3V, 5V). The processor core voltage is generated by a switched voltage regulator, sourced from the 5V plane. The processor signals its required core voltage by 6 dedicated pins according to Intel's IMVP-IV voltage regulator specification.

0.09µ (Dothan) Processors Supported								
Processor	Speed min/max [GHz]	Host Bus [MHz]	L2 Cache [MB]	TDP [W]	Die Temp [°C]	CPU ID	Stepping	sSpec
ULV Celeron M 373 ^{1) 2)}	1.0/1.0	400	0.5	5	0-100	06D8h	C-0	SL8LW
LV Pentium M 738 ²⁾	0.6/1.4	400	2	10	0-100	06D6h 06D8h	B-0 C-0	SL7P9 SL89N
Pentium M 745 ²⁾	0.6/1.8	400	2	21	0-100	06D6h 06D8h	B-0 C-0	SL7Q6 SL8U8
Pentium M 760 ²⁾	0.8/2.0	533	2	27	0-100	06D8h	C-0	SL869

- ¹⁾ This processor does not support SpeedStep® technology, since it runs at a fixed core speed.
- ²⁾ Following the Intel Embedded Roadmap, this processor is recommended for long time availability.

Thermal Considerations

In order to avoid malfunctioning of the CCD-CALYPSO, take care of appropriate cooling of the processor and system, e.g. by a cooling fan suitable to the maximum power consumption of the CPU chip actually in use. Please note, that the processors temperature is steadily measured by a special controller (LM87), attached to the onboard SMBus® (System Management Bus). A second temperature sensor internal to the LM87 allows for acquisition of the boards surface temperature. Beside this the LM87 also monitors most of the supply voltages. A suitable software to display both, the temperatures as well as the supply voltages, is MBM (Motherboard Monitor), which can be downloaded from the web. After installation, both temperatures and voltages can be observed permanently from the Windows taskbar.

The CCD-CALYPSO is equipped with a passive heatsink. Its height takes into account the 4HP limitation in mounting space of a CPCI board. In addition, a forced vertical airflow through the system enclosure (e.g. bottom mount fan unit) is strongly recommended ($> 15\text{m}^3/\text{h}$ or 200LFM around the CPU slot). As an exception, the CCD-2-CALYPSO (ULV Celeron M 1GHz) can be operated with natural convection only. Be sure to thoroughly discuss your actual cooling needs with EKF. Generally, the faster the CPU speed the higher its power consumption. For higher ambient temperatures, consider increasing the forced airflow to 400 or 600LFM.

The table showing the supported processors above give also the maximum power consumption (TDP = Thermal Design Power) of a particular processor. Fortunately, the power consumption is by far lower when executing typical Windows or Linux tasks. The heat dissipation increases when e.g. rendering software like the Acrobat Distiller is executed.

The Pentium M processors support Intel's Enhanced SpeedStep® technology. This enables dynamic switching between multiple core voltages and frequencies depending on core temperature and currently required performance. The processors are able to reduce their core speed and core voltage in up to 8 steps down to 600MHz. This leads to an obvious reduction of power consumption (max. 7.5W @600MHz) resulting in less heating. This mode of lowering the processor core temperature is called TM2 (TM=Thermal Monitor). Note, that TM2 is not supported by Celeron M processors.

Another way to reduce power consumption is to modulate the processor clock. This mode (TM1) is supported also by the Celeron M processors and is achieved by actuating the 'Stop Clock' input of the CPU. A throttling of 50% e.g. means a duty cycle of 50% on the stop clock input. However, while saving considerable power consumption, the data throughput of the processor is also reduced. The processor works at full speed until the core temperature reaches a critical value. Then the processor is throttled by 50%. As soon as the high temperature situation disappears the throttling will be disabled and the processors runs at full speed again.

A similar feature is embedded within the Graphics and Memory Controller (GMCH) i915GM. An on-die temperature sensor is used to protect the GMCH from exceeding its maximum junction temperature ($T_{j,max} = 105^\circ\text{C}$) by reducing the memory bandwidth.

These features are controllable by BIOS menu entries. By default the BIOS of the CCD-CALYPSO enables mode TM2 which is the most efficient.

Main Memory

The CCD-CALYPSO is equipped with two sockets for installing 200-pin SO-DIMM modules (module height = 1.25 inch). Supported are unbuffered DDR2 SO-DIMMs ($V_{CC}=1.8V$) without ECC featuring on-die termination (ODT), according the PC2-3200 or PC2-4200 specification. Minimum memory size is 128MB; maximum memory size is 2GB. Due to the video requirements of the i915GM chipset, a minimum of 2x256MB of memory is recommended for the operating systems Windows NT 4.0, Windows 2000 or Windows XP (some of the system memory is dedicated to the graphics controller). The contents of the SPD EEPROM on the SO-DIMMs is used by the BIOS at POST (Power-on Self Test) to program the memory controller within the chipset.

The i915GM chipset supports symmetric and asymmetric memory organization. The maximum memory performance can be obtained by using the symmetric mode. To achieve this mode two SO-DIMMs of equal capacity must be installed in the memory sockets. In asymmetric mode different memory modules may be used with the drawback of less bandwidth. A special case of asymmetric mode is to populate only one memory module (i.e. one socket may be left empty).

LAN Subsystem

The Ethernet LAN subsystem is composed of two Intel 82573 Gigabit Ethernet controllers that provide also legacy 10Base-T and 100Base-TX connectivity. The Ethernet ports are fed to two RJ45 jacks located in the front panel. Each port includes the following features:

- One PCI Express lane per Ethernet controller (250MB/s)
- 1000Base-Tx (Gigabit Ethernet), 100Base-TX (Fast Ethernet) and 10Base-T (Classic Ethernet) capability
- Half- or full-duplex operation
- IEEE 802.3 \square Auto-Negotiation for the fastest available connection
- Jumperless configuration (complete software-configurable)
- Two bicoloured LEDs integrated into the dedicated RJ-45 connector to signal the LAN link, the LAN connection speed and activity status.

Each NIC (Networking Interface Controller) is connected by a single PCI Express lane to the chipset (ICH6). Their MAC addresses (unique hardware number) are stored in dedicated EEPROMs. The Intel Ethernet software and drivers for the 82573 is available from Intel's World Wide Web site for download.

Serial ATA Interface (SATA)

The CCD-CALYPSO provides three serial ATA (SATA) ports each capable of transferring 150MB/s. Integrated within the ICH6 the SATA controller features different modes to support also legacy operating systems. The SATA channels are routed to the CompactPCI J2 connector, thus they are accessible via the rear I/O transition module CCT-RIO.

A LED named HD located in the front panel, signals disk activity status of the SATA and IDE devices.

Available for download from Intel's web site are drivers for popular operating systems, e.g. Windows® 2000, Windows® XP and Linux.

Enhanced IDE Interface

The EIDE interface handles the exchange of information between the processor and peripheral devices like hard disks, ATA CompactFlash cards and CD-ROM drives. The interface supports:

- Up to two ATA devices
- PIO Mode 3/4, Ultra ATA/33, Ultra ATA/66, Ultra ATA/100

The IDE interface is routed to the on-board connectors PIDE1 and PIDE2 (T:top side, B:bottom side of the board). PIDE is used to interface to the CompactFlash Card adapter C10-CFA or to the expansion board CCA-LAMBADA. Use the C10-CFA adapter to attach a CompactFlash ATA style silicon disk, whenever a hard disk is not suitable for your system, or as an additional mass storage device. The CCA-LAMBADA expansion board is capable to carry an on-board 1.8" or 2.5" hard disk drive. When using the 1.8" option the concurrent operation of a CompactFlash device is possible.

A LED named HD located in the front panel, signals disk activity status of the IDE and SATA devices.

The IDE controller is integrated into the ICH6. Ultra ATA IDE drivers can be downloaded from the Intel web site.

Graphics Subsystem

The graphics subsystem is part of the Intel i915GM Graphics/Memory Controller Hub (GMCH). The CCD-CALYPSO is provided with a DVI-I graphics connector. This is both a digital and analog interface. Recent digital input flat-panel displays are widely available with this connector style. For classic monitors, adapters or adapter cables can be used for converting from DVI-I to the 15-pin HD D-SUB connector.

A special display transmitter chip is used to convert Intel's proprietary, PCI express based SDVO interface to the differential DVI signals. The SiI1362 (Silicon Image) transmitter uses PanelLink® Digital technology to support displays ranging from VGA to UXGA resolutions (25 - 165Mpps) in a single link interface.

The GMCH supports several video resolutions and refresh rates. A partial list is contained in the table below. Please note, that flat-panel displays should be operated with their maximum resolution at 60Hz refresh rate.

Partial List of i915GM GMCH Video Modes (analog / digital)					
Resolution	60Hz	70Hz	72Hz	75Hz	85Hz
640x480	✓ / ✓	✓ / ✓	✓ / ✓	✓ / ✓	✓ / ✓
800x600	✓ / ✓	✓ / ✓	✓ / ✓	✓ / ✓	✓ / ✓
1024x768	✓ / ✓ ¹⁾	✓ / ✓	✓ / ✓	✓ / ✓	✓ / ✓
1280x1024	✓ / ✓ ¹⁾	✓ / ✓	✓ / ✓	✓ / ✓	✓ / ✓
1600x1200	✓ / ✓ ¹⁾	✓ / -	✓ / -	✓ / -	✓ / -
2048x1536	✓ / -	✓ / -	✓ / -	✓ / -	- / -

¹⁾ This video mode is suitable for popular flat-panel displays.

As an option, the CCD-CALYPSO can be equipped with an ordinary HD D-Sub 15-lead connector (VGA style). This connector is suitable for analog signals only, so the PanelLink transmitter is not stuffed with this option. Nevertheless also flat-panel displays can be attached to the D-Sub connector but with minor reduced image quality.

Independent from the video connector actually in use, DVI or VGA, the VESA DDC 2B standard is supported. This is a two-wire serial bus (clock, data), which is controlled by the GMCH and allows to read out important parameters, e.g. the maximum allowable resolution, from the attached monitor. In addition, DDC Power (+5V) is delivered to either connector. A resettable fuse is stuffed to protect the board from an external short-circuit condition (0.75A).

Graphics drivers for the i915GM can be downloaded from the Intel web site.

Real-Time Clock

The CCD-CALYPSO has a time-of-day clock and 100-year calendar, integrated into the ICH6. A battery on the board keeps the clock current when the computer is turned off. The CCD uses a BR2032 lithium battery soldered in the board, giving an autonomy of more than 3 years. Under normal conditions, replacement should be superfluous during lifetime of the board.

Universal Serial Bus (USB)

The CCD-CALYPSO is provided with seven USB ports, all of them are USB 2.0 capable. Two USB interfaces are routed to front panel connectors, two ports are feed to the expansion board interface connectors PEXP, and three ports are optionally available for rear I/O across the J2/P2 *CompactPCI* connector.

The front panel USB connectors can source up to 0.5A/5V each, over-current protected by two electronic switches. Protection for the USB ports on the expansion interface and on the rear I/O connector is located on the CCA-LAMBADA and the CCT-RIO respective. The USB controllers are integrated into the ICH6.

LPC Super-I/O Interface

In a modern system, legacy ports as PS/2 keyboard/mouse, COM1/2 and LPT have been replaced by USB and Ethernet connectivity. The 1.4MB floppy disk drive has been swapped against LS-120 or CD-RW drives, attached to a SATA connector, or USB memory sticks. Hence, the CCD-CALYPSO is virtually provided with all necessary I/O ports. However, for compatibility purposes the CCD is additionally equipped with a simple Super-I/O chip, for optional rear I/O of PS/2 keyboard/mouse and COM1 (TTL level only) across the J2/P2 CPCI connector. The Super-I/O controller resides on the local LPC bus (LPC = Low Pin Count interface standard), which is a serialized ISA bus replacement.

As an alternative, EKF offers the CCA-LAMBADA, an expansion module to the CCD-CALYPSO, featuring all classic Super-I/O functionality. The CCA-LAMBADA is a 3U Eurocard with a 4HP (single) width front panel. Access to the connectors PS/2 (mouse, keyboard), COM, USB and audio in/out is given directly from the front panel. The CCA-LAMBADA connects to the CCD-CALYPSO across the

connector PEXPT or PEXPB. The CCA-LAMBADA can be attached either to the top or to the bottom of the CCD-CALYPSO.

Reset/Watchdog

The CCD-CALYPSO is provided with two supervisor circuits to monitor the supply voltages 1.8V, 3.3V, 5V, and to generate a clean power-on reset signal.

Due to lack of space within the front panel the CCD-CALYPSO does not offer a classical push button to force a manual board reset. Nevertheless it is possible to reset the board manually. The handle within the front panel contains a micro switch that is used to generate a board reset signal. By pressing the handle's red push button a short reset pulse is triggered. To generate another reset the handle must be closed and unlocked again. The manual reset could be passivated on customers request.

An alternative (and recommended) way to generate a system reset is to activate the signal PRST# located on CompactPCI connector J2 pin C17. Pulling this signal to GND will have the same effect as to push the handle's red push button.

The healthy state of the CCD-CALYPSO is signalled by the LED PG (Power Good) located in the front panel. As soon as this LED begins to shine all power voltages are within their specifications and the reset signal has been deasserted.

An important reliability feature is the watchdog function, which is programmable by software. The behaviour of the watchdog is defined within the PLD, which activates/deactivates the watchdog and controls its time-out period. The time-out delay is adjustable in the steps 2, 10, 50 and 255 seconds. After alerting the WD and programming the time-out value, the related software (e.g. application program) must trigger the watchdog periodically. All watchdog related functions are made available by calling service requests within the BIOS.

The watchdog is in a passive state after a system reset. There is no need to trigger it at boot time. The watchdog is activated on the first trigger request. If the duration between two trigger requests exceeds the programmed period, the watchdog times out and a system reset will be generated. The watchdog remains in the active state until the next system reset. There is no way to disable it once it had been put on alert, whereas it is possible to reprogram its time-out value at any time.

Firmware Hub (Flash BIOS)

The BIOS is stored in an 82802 8Mbit Firmware Hub (there are second sources in use with deviant part numbers). The firmware hub contains a nonvolatile memory core based on flash technology, allowing the BIOS to be upgraded.

The FWH can be reprogrammed (if suitable) by a DOS based tool. This program and the latest CCD-CALYPSO BIOS are available from the EKF website. Read carefully the enclosed instructions. If the programming procedure fails e.g. caused by a power interruption, the CCD-CALYPSO may no more be operable. In this case you would have to send in the board, because the BIOS is directly soldered to the PCB and cannot be changed by the user.

PG (Power Good) LED

The CCD-CALYPSO offers a software programmable LED labelled PG located within the front panel. After system reset, this LED defaults to signal the board healthy respective power good state. This LED changes its function by calling an appropriate BIOS request and is then controlled by software only. The PG LED remains in the programmable state until the next system reset occurs.

HD (Hard Disk Activity) LED

The CCD-CALYPSO offers a LED, marked as HD (placed within the front panel). This LED signals activity on any device attached to the SATA or the IDE ports.

GP (General Purpose) LED

A second, programmable LED can be also observed from the front panel. The status of the GP LED is controlled by the GPO18 output of the ICH6. Setting this pin to 1 will switch on the LED. As of current, the GP LED is not dedicated to any particular hardware or firmware function (this may change in the future).

Hot Swap Detection

The *CompactPCI* specification added the signal ENUM# to the PCI bus to allow the board hot swapping. This signal is routed to the GPI3 of the ICH6. A System Management Interrupt (SMI) can be requested if ENUM# changes by insertion or removal of a board.

Note that the CCD-CALYPSO itself is not a hot swap device, because it makes no sense to remove the system controller from a *CompactPCI* system. However, it is capable to recognize the hot swap of peripheral boards and to start software that is doing any necessary system reconfiguration.

Power Supply Status (DEG#, FAL#)

Power supply failures may be detected before the system crashes down by monitoring the signals DEG# or FAL#. These active low lines are additions of the *CompactPCI* specification and may be driven by the power supply. DEG# signals the degrading of the supply voltages, FAL# there possible failure. On the CCD-CALYPSO the signal FAL# is routed to the GPI4 and DEG# to the GPI5 of the ICH6.

PXI Trigger Signals

As an option, the CCD-CALYPSO supports four of the eight trigger signals of the PXI standard, as defined by National Instruments. The trigger signals are provided by the local SIO (Super-I/O) chip IT8761E. GPIO20/21 are routed to TRIG0/1, and GPIO26/27 are used to control TRIG6/7. These signals can also be used as GPIO lines in a non-PXI environment.

Local GPIO Option

In addition to the GPIO / PXI-Trigger lines optionally available on J2, the expansion connector PEXP provides another two GPIO lines available for user specific application. The 5V TTL signals sio_gpio16/17 are controlled by the on-board SIO IT8761E, with an internal 50kΩ PU resistor and capable of sinking 24mA each.

Rear I/O Options

Optionally, the CCD-CALYPSO can be used for rear I/O with respect to the following functions:

- Analog Graphics
- 1 Gigabit Ethernet Port
- 3 SATA Ports
- 3 USB Ports
- Keyboard, Mouse
- COM1 (TTL Level)

The analog graphics and the gigabit ethernet port 1 signals are routed to multiplexers on the CCD-CALYPSO. These switches, controlled by BIOS, select either the front panel or the rear I/O connection. The COM1 port does not include the physical transceiver (TTL level only). This transceiver is located on the rear I/O module CCT-RIO instead. Each of the above functions can be activated individually (by appropriate stuffing/removing of resistor networks).

The CCD CPU card by default is suitable for a 64-bit *CompactPCI* backplane. However, the J2/P2 pin assignments of a 64-bit CPCI backplane differ substantially from a *CompactPCI* rear I/O backplane. Hence [usage of the rear I/O features is available only as stuffing options on the CCD CPU board, which have to be ordered explicitly](#).

[The system in use must be equipped with a P2 *CompactPCI* rear I/O backplane](#). If the system is provided with a P2 *CompactPCI* 64-bit backplane instead, several of the CCD rear I/O signals will collide with the 64-bit address/data lines on the backplane, with unpredictable results regarding the rear I/O signal integrity.



Single Slot Rear I/O Backplane EKF Part No. 932.4.01.080

Installing and Replacing Components

Before You Begin

Warnings

The procedures in this chapter assume familiarity with the general terminology associated with industrial electronics and with safety practices and regulatory compliance required for using and modifying electronic equipment. Disconnect any telecommunication links, networks or procedures described in this chapter. Failure links before you open the system or perform or equipment damage. Some parts of the the power switch is in its off state.



the system from its power source and from modems before performing any of the to disconnect power, or telecommunication any procedures can result in personal injury system can continue to operate even though

Caution

Electrostatic discharge (ESD) can damage components. Perform the procedures described in this chapter only at an ESD workstation. If such a some ESD protection by wearing an metal part of the system chassis or board original ESD protected packaging. Retain the antistatic box) in case of returning the board to EKF for rapair.



station is not available, you can provide antistatic wrist strap and attaching it to a front panel. Store the board only in its original packaging (antistatic bag and

Installing the Board

Warning

This procedure should be done only by qualified technical personnel. Disconnect the system from its power source before doing the procedures described here. Failure to disconnect power, or telecommunication links before you open the system or perform any procedures can result in personal injury or equipment damage.

Typically you will perform the following steps:

- Switch off the system, remove the AC power cord
- Attach your antistatic wrist strap to a metallic part of the system
- Remove the board packaging, be sure to touch the board only at the front panel
- Identify the related *CompactPCI* slot (peripheral slot for I/O boards, system slot for CPU boards, with the system slot typically most right or most left to the backplane)
- Insert card carefully (be sure not to damage components mounted on the bottom side of the board by scratching neighbored front panels)
- A card with onboard connectors requires attachment of associated cabling now
- Lock the ejector lever, fix screws at the front panel (top/bottom)
- Retain original packaging in case of return



Removing the Board

Warning

This procedure should be done only by qualified technical personnel. Disconnect the system from its power source before doing the procedures described here. Failure to disconnect power, or telecommunication links before you open the system or perform any procedures can result in personal injury or equipment damage.

Typically you will perform the following steps:

- Switch off the system, remove the AC power cord
- Attach your antistatic wrist strap to a metallic part of the system
- Identify the board, be sure to touch the board only at the front panel
- unfasten both front panel screws (top/bottom), unlock the ejector lever
- Remove any onboard cabling assembly
- Activate the ejector lever
- Remove the card carefully (be sure not to damage components mounted on the bottom side of the board by scratching neighbored front panels)
- Store board in the original packaging, do not touch any components, hold the board at the front panel only



Warning

Do not expose the card to fire. Battery cells and other components could explode and cause personal injury.





EMC Recommendations

In order to comply with the CE regulations for EMC, it is mandatory to observe the following rules:

- The chassis or rack including other boards in use must comply entirely with CE
- Close all board slots not in use with a blind front panel
- Front panels must be fastened by built-in screws
- Cover any unused front panel mounted connector with a shielding cap
- External communications cable assemblies must be shielded (shield connected only at one end of the cable)
- Use ferrite beads for cabling wherever appropriate
- Some connectors may require additional isolating parts

Reccomended Accessories

Blind CPCI Front Panels	EKF Elektronik	Widths currently available (1HP=5.08mm): with handle 4HP/8HP without handle 2HP/4HP/8HP/10HP/12HP
Ferrit Bead Filters	ARP Datacom, 63115 Dietzenbach	Ordering No. 102 820 (cable diameter 6.5mm) 102 821 (cable diameter 10.0mm) 102 822 (cable diameter 13.0mm)
Metal Shielding Caps	Conec-Polytronic, 59557 Lippstadt	Ordering No. CDFA 09 165 X 13129 X (DB9) CDSFA 15 165 X 12979 X (DB15) CDSFA 25 165 X 12989 X (DB25)

Installing or Replacing the Memory Modules

Note: If you decide to replace the memory, observe the precautions in 'Before You Begin'

By default, the CCD-CALYPSO comes fully equipped and tested with two DDR2 SD-RAM memory modules. So normally there should be no need to install the memory modules.

The CCD-CALYPSO requires at least one PC2-3200/4200 (400/533MHz) DDR2 SDRAM SO-DIMM module, for better performance two SO-DIMMs of equal capacity are recommended. Further it is highly recommended that Serial Presence Detect (SPD) SO-DIMMs be used, since this allows the chipset to accurately configure the memory settings for optimum performance.

A replacement memory module must match the 200-pin SO-DIMM form factor (known from Notebook PCs), DDR2, $V_{CC}=1.8V$, PC2-3200/PC2-4200 (400/533MHz), on-die termination (ODT), unbuffered, non-ECC style. Suitable modules are available up to 1GB. The i915GM supports modules of up to a maximum of 14 address lines (A0...A13). Memory modules organized by more than 14 address lines are not suitable.

Replacement of the Battery

When your system is turned off, a battery maintains the voltage to run the time-of-day clock and to keep the values in the CMOS RAM. The battery should last during the lifetime of the CCD-CALYPSO. For replacement, the old battery must be desoldered, and the new one soldered. We suggest that you send back the board to EKF for battery replacement.

Warning

Danger of explosion if the battery is incorrectly replaced. Replace only with the same or equivalent type. Do not expose a battery to fire.



Technical Reference

Local PCI Devices

The following table shows the on-board PCI devices and their location within the PCI configuration space. These devices consist of the Ethernet controllers and several devices within the i915GM chip set.

Bus Number	Device Number	Function Number	Vendor ID	Device ID	Description
0	0	0	0x8086	0x2590	Host Bridge
0	2	0	0x8086	0x2592	Internal Graphics Device
0	2	1	0x8086	0x2792	Int. Graphics Config. Regs.
0	27	0	0x8086	0x2668	Intel High Definition Audio
0	28	0	0x8086	0x2660	PCI Express Port 1
0	28	1	0x8086	0x2662	PCI Express Port 2
0	28	2	0x8086	0x2664	PCI Express Port 3
0	28	3	0x8086	0x2666	PCI Express Port 4
0	29	0	0x8086	0x2658	USB UHCI Controller #1
0	29	1	0x8086	0x2659	USB UHCI Controller #2
0	29	2	0x8086	0x265A	USB UHCI Controller #3
0	29	3	0x8086	0x265B	USB UHCI Controller #4
0	29	7	0x8086	0x265C	USB 2.0 EHCI Controller
0	30	0	0x8086	0x244E	PCI-to-PCI Bridge
0	30	2	0x8086	0x266E	AC'97 Audio Controller
0	30	3	0x8086	0x266D	AC'97 Modem Controller
0	31	0	0x8086	0x2640	LPC Bridge
0	31	1	0x8086	0x266F	IDE Controller
0	31	2	0x8086	0x2651	SATA Controller
0	31	3	0x8086	0x266A	SMB Controller
3 ¹⁾	0	0	0x8086	0x108B ²⁾ 0x109A ²⁾	Ethernet Controller NC1
4 ¹⁾	0	0	0x8086	0x108B ²⁾ 0x109A ²⁾	Ethernet Controller NC2

¹⁾ This bus number can vary depending on the PCI enumeration schema implemented in BIOS.

²⁾ The CCD-CALYPSO is available with a 82573E (0x108B) or 82573L (0x109A) Ethernet controller.

Local SMB Devices

The CCD-CALYPSO contains a few devices that are reachable via the System Management Bus (SMBus). These are the clock generation chip, the SPD EEPROMs on the SO-DIMM memory modules, a general purpose serial EEPROM and a supply voltage and CPU temperature controlling device in particular. Other devices could be connected to the SMB via the *CompactPCI* signals IPMB SCL (J1 B17) and IPMB SDA (J1 C17).

Address	Description
0x58	Hardware Monitor/CPU Temperature Sensor (LM87)
0xA0	SPD of SODIMM1
0xA2	SPD of SODIMM2
0xAE	General Purpose EEPROM
0xD2	Main Clock Generation (CK-410M)

Hardware Monitor LM87

Located on the SMBus the CCD-CALYPSO offers a hardware monitor of type LM87/NSC. This device is capable to observe board and CPU temperatures as well as several supply voltages generated on the board with a resolution of 8 bit. The following table shows the mapping of the voltage inputs of the LM87 to the corresponding supply voltages of the CCD-CALYPSO:

Input	Source	Resolution [mV]	Register
AIN1	CPU Core Voltage	9.8	0x28
AIN2	+1.05V	9.8	0x29
VCCP1	+1.5V	14.1	0x21
VCCP2/D2-	+1.8V	14.1	0x25
+2.5V/D2+	+2.5V	13	0x20
+3.3V	+3.3V	17.2	0x22
+5V	+5V	26	0x23
+12V	+12V ¹⁾	62.5	0x24

¹⁾ Revision 2 or higher.

Beside the continuous measuring of temperatures and voltages the LM87 may compare these values against programmable upper and lower boundaries. As soon as a measurement violates the allowed value, the LM87 may request an interrupt via the GPI[11] of the ICH6.

GPIO Usage

GPIO Usage ICH6

CCD-CALYPSO GPIO Usage ICH6				
GPIO	Type	Tol.	Function	Description
GPI 0	I	5V	CPCI_REQ6#	CompactPCI Bus Request Line #6
GPI 1	I	5V	CPCI_REQ5#	CompactPCI Bus Request Line #5
GPI 2	I	5V	CPCI_INTP	CompactPCI Interrupt Request Line INTP
GPI 3	I	5V	CPCI_ENUM#	CompactPCI System Enumeration Line ENUM#
GPI 4	I	5V	CPCI_FAL#	CompactPCI Power Failure Line FAL#
GPI 5	I	5V	CPCI_DEG#	CompactPCI Power Degeneration Line DEG#
GPI 6	I	3.3V	GP_JUMP#	BIOS CMOS Values Reset Jumper JGP
GPI 7	I	3.3V	CPCI_SYSEN#	CompactPCI System Slot Enable Line SYSEN#
GPI 8	I	3.3V	N/A	Not used on CCD (fixed to GND)
GPI 9	I	3.3V	USB_OC4#	USB Port #4 Overcurrent Detect Line
GPI 10	I	3.3V	USB_OC5#	USB Port #5 Overcurrent Detect Line
GPI 11	I	3.3V	HM_INT#	Hardware Monitor LM87 Interrupt Line
GPI 12	I	3.3V	EXP_PME#	Expansion Interface PME# Line
GPI 13	I	3.3V	EXP_SMI#	Expansion Interface SMI# Line
GPI 14	I	3.3V	N/A	Not used on CCD (fixed to GND)
GPI 15	I	3.3V	N/A	Not used on CCD (fixed to GND)
GPO 16	O	3.3V	CPCI_GNT6#	CompactPCI Bus Grant Line #6
GPO 17	O	3.3V	CPCI_GNT5#	CompactPCI Bus Grant Line #5
GPO 18	O	3.3V	GP_LED	General Purpose LED Control (via PLD)
GPO 19	O	3.3V	N/A	Not used on CCD
GPO 20	O	3.3V	PLD_SCL	Local Option Reg Interface (within PLD)
GPO 21	O	3.3V	PLD_SDA	Local Option Reg Interface (within PLD)
GPO 23	O	3.3V	CPCI_INTS_EN	Connect SERIRQ to CompactPCI Line INTS LOW: SERIRQ disconnected from INTS HIGH: SERIRQ connected to INTS
GPIO 24	O	3.3V	CPCI_SMB_EN	Connect CPCI IPMB to local SMBus LOW: IPMB disconnected from SMBus HIGH: IPMB connected to SMBus
GPIO 25	O	3.3V	CPCI_CLK_EN	Enable CompactPCI Clock Buffer

CCD-CALYPSO GPIO Usage ICH6				
GPIO	Type	Tol.	Function	Description
GPI 26	I	3.3V	N/A	Not used on CCD (fixed to GND)
GPIO 27	O	3.3V	VGA_SWITCH	VGA Switching Line: LOW: VGA via Rear I/O HIGH: VGA via Front I/O
GPIO 28	O	3.3V	ETH_SWITCH	Ethernet Switching Line: LOW: Ethernet Port #1 via Rear I/O HIGH: Ethernet Port #1 via Front I/O
GPI 29-31	I	3.3V	BOARD_CFG	Board Configuration Jumpers
GPIO 32	O	3.3V	NC1_EN	Enable Ethernet Controller NC1
GPIO 33	O	3.3V	NC2_EN	Enable Ethernet Controller NC2
GPIO 34	I/O	3.3V	N/A	Not used on CCD
GPI 40	I	5V	CPCI_REQ4#	CompactPCI Bus Request Line #4
GPI 41	I	3.3V	LPC_DRQEXP#	Expansion Interface LPC DMA Request Line
GPO 48	O	3.3V	CPCI_GNT4#	CompactPCI Bus Grant Line #4
GPO 49	OD	1.05V	CPU_PWRGD	CPU Power Good Line

GPIO Usage FWH

CCD-CALYPSO GPIO Usage FWH																			
GPIO	Type	Tol.	Function	Description															
GPI 0	I	3.3V	FWH_ID	FWH Identity: Fixed to GND (indicates FWH #1)															
GPI 1	I	3.3V	IDE_CLBID#	IDE 80pol. Cable Detection Line															
GPI 2	I	3.3V	WDOGRST	Last Hardware Reset caused by watchdog															
GPI 3	I	3.3V	LSB PCB REV	<table border="1"> <thead> <tr> <th>GPI 4</th> <th>GPI 3</th> <th>Rev.</th> </tr> </thead> <tbody> <tr> <td>0</td> <td>0</td> <td>0</td> </tr> <tr> <td>0</td> <td>1</td> <td>1</td> </tr> <tr> <td>1</td> <td>0</td> <td>2</td> </tr> <tr> <td>1</td> <td>1</td> <td>3+</td> </tr> </tbody> </table>	GPI 4	GPI 3	Rev.	0	0	0	0	1	1	1	0	2	1	1	3+
GPI 4	GPI 3	Rev.																	
0	0	0																	
0	1	1																	
1	0	2																	
1	1	3+																	
GPI 4	I	3.3V	MSB PCB REV																

GPIO Usage SIO

CCD-CALYPSO GPIO Usage SIO				
GPIO	Type	Tol.	Function	Description
GPIO 13	I	5V ¹⁾	CPCI_64EN#	CompactPCI 64-Bit Backplane
GPIO 14/15	I/O	5V/8mA ¹⁾	N/A	Not used on CCD
GPIO 16	I/O	5V/24mA ¹⁾	SIO_GPIO16	GPIO on Expansion Interface PEXP Pin 29
GPIO 17	I/O	5V/24mA ¹⁾	SIO_GPIO17	GPIO on Expansion Interface PEXP Pin 30
GPIO 20	I/O	5V/8mA ¹⁾	PXI_TRIG0	PXI Trigger 0 on CompactPCI J2 Pin B16
GPIO 21	I/O	5V/8mA ¹⁾	PXI_TRIG1	PXI Trigger 1 on CompactPCI J2 Pin A16
GPIO 22-25	I/O	5V/24mA ¹⁾	N/A	Not used on CCD
GPIO 26	I/O	5V/24mA ¹⁾	PXI_TRIG6	PXI Trigger 6 on CompactPCI J2 Pin E18
GPIO 27	I/O	5V/24mA ¹⁾	PXI_TRIG7	PXI Trigger 7 on CompactPCI J2 Pin E16

¹⁾ These GPIOs have pullup resistors of approx. 50kΩ within the SIO.

Configuration Jumpers

Reset Jumper BIOS CMOS RAM Values (JGP)

The jumper JGP is used to bring the contents of the battery backed CMOS RAM to a default state. The BIOS uses the CMOS to store configuration values, e.g. the actual boot devices. Using this jumper is only necessary, if it is not possible to enter the setup of the BIOS. To reset the CMOS RAM mount a jumper on JGP and perform a system reset. As long as the jumper is stuffed the BIOS will use the default CMOS values after any system reset. To get normal operation again, the jumper has to be removed.



JGP	Function
Jumper OFF ¹⁾	No CMOS reset performed
Jumper ON	CMOS reset performed

¹⁾ This setting is the factory default.

Reset Jumper ICH6 RTC Core (JRTC)

The jumper JRTC is used to reset the battery backed core of the ICH6. This effects some registers within the ICH6 RTC core that are important before the CPU starts its work after a system reset. Note that JRTC will neither perform the clearing of the CMOS RAM values nor resets the real time clock. To reset the RTC core the board must be removed from the system rack. Short-circuit the pins of JRTC for about 1 sec. After that reinstall the board to the system and switch on the power. It is important to accomplish the RTC reset while the board has no power.

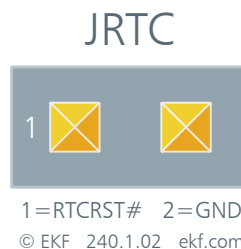

JRTC	Function
Jumper OFF ¹⁾	No RTC reset performed
Jumper ON	RTC reset performed

¹⁾ This setting is the factory default.

Connectors

Caution

Some of the internal connectors provide operating voltage (3.3V and 5V) to devices inside the system chassis, such as internal peripherals. Not all of these connectors are overcurrent protected. Do not use these internal connectors for powering devices external to the computer chassis. A fault in the load presented by the external devices could cause damage to the board, the interconnecting cable and the external devices themselves.

Front Panel Connectors

© EKF • draft only - do not scale • ekf.com

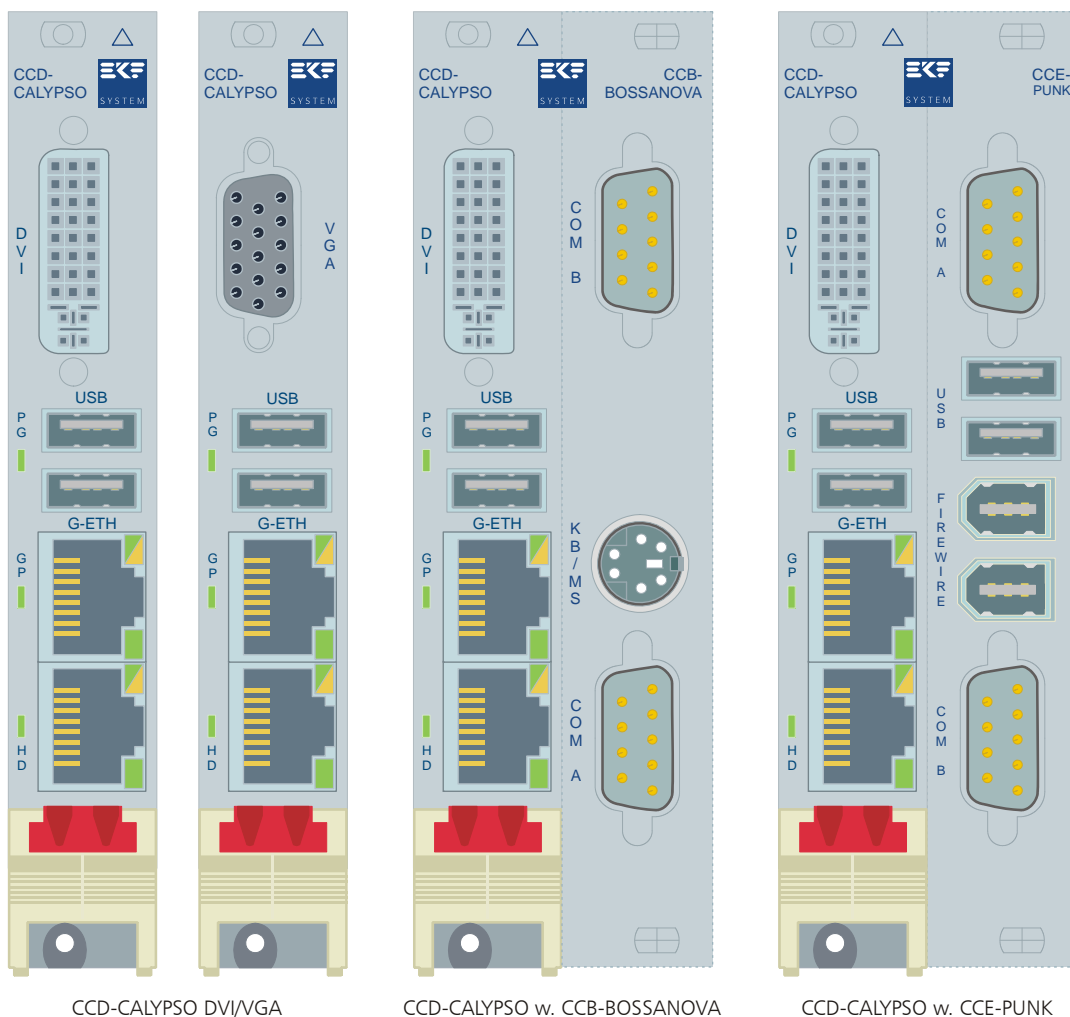

Typical CCD-CALYPSO Front Panel Elements

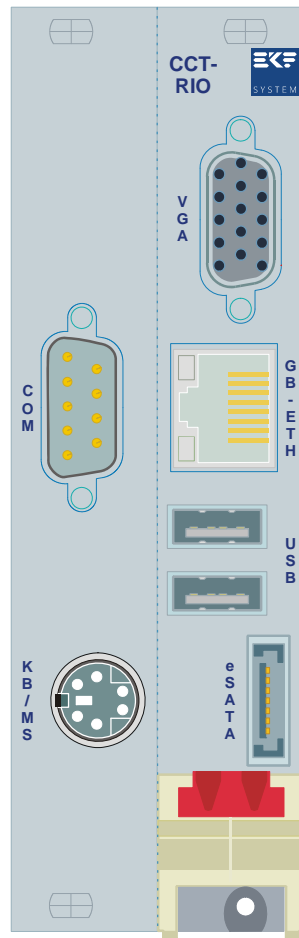

CCT-RIO 4/8HP

Typical CCT-RIO Rear Panel Elements

Video Monitor Connector DVI-I

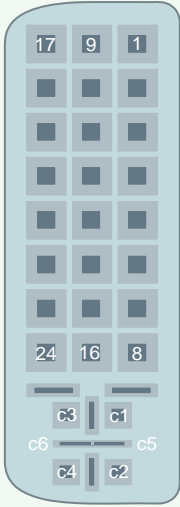
DVI-I						
	17	TX0-	9	TX1-	1	TX2-
	18	TX0+	10	TX1+	2	TX2+
	19	GND	11	GND	3	GND
	20		12		4	
	21		13		5	
	22	GND	14	DDC_POW ¹⁾	6	DDC_SCL ²⁾
	23	TXC+	15	GND	7	DDC_SDA ²⁾
	24	TXC-	16	DVI_HP	8	VSYNC ²⁾
			c3	BLUE ²⁾	c1	RED ²⁾
			c6	GND	c5	GND
		c4	HSYNC ²⁾	c2	GREEN ²⁾	

¹⁾ +5V protected by a PolySwitch Fuse 0.75A.

²⁾ This signal may be switched either to the front connector or to the rear I/O adapter CCT-RIO.

For attachment of an ordinary analog RGB monitor to the DVI-I receptacle, there are both adapters and also adapter cables available from DVI-I to the HD-SUB15 connector. Attachment of digital monitors (flat panel displays) should be done by means of a DVI to DVI cable (single link style cable is sufficient).

Video Monitor Connector VGA

As an option, the CCD-CALYPSO can be equipped with a legacy VGA connector (High-Density D-Sub 15-position female connector). The VGA connector replaces the DVI-I receptacle, and the digital video interface therefore is not available with this option.

VGA (Option)		
	1	RED ²⁾
	2	GREEN ²⁾
	3	BLUE ²⁾
	4	NC
	5	GND
	6	GND
	7	GND
	8	GND
	9	DDC_POW ¹⁾
	10	GND
	11	NC
	12	DDC_SDA ²⁾
	13	HSYNC ²⁾
	14	VSYNC ²⁾
	15	DDC_SCL ²⁾

¹⁾ +5V protected by a PolySwitch Fuse 0.75A

²⁾ This signal may be switched either to the front connector or to the rear I/O adapter CCT-RIO.

USB Connectors

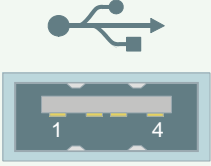
USB Ports 1/2		
 <p>¹⁾ +5V protected by an Electronic Fuse 0.5A</p>	1	POW ¹⁾
	2	USB DATA NEG
	3	USB DATA POS
	4	GND

Ethernet Connectors

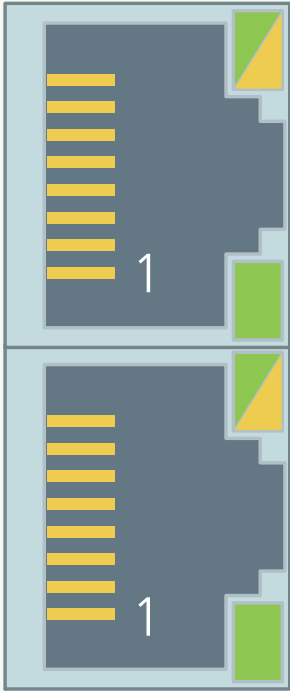
G-ETH1/2 (RJ45)		
 <p>270.02.08.5</p>	1	NC1_MDX0+ ¹⁾
	2	NC1_MDX0- ¹⁾
	3	NC1_MDX1+ ¹⁾
	4	NC1_MDX2+ ¹⁾
	5	NC1_MDX2- ¹⁾
	6	NC1_MDX1- ¹⁾
	7	NC1_MDX3+ ¹⁾
	8	NC1_MDX3- ¹⁾
	1	NC2_MDX0+
	2	NC2_MDX0-
	3	NC2_MDX1+
	4	NC2_MDX2+
	5	NC2_MDX2-
	6	NC2_MDX1-
	7	NC2_MDX3+
	8	NC2_MDX3-

¹⁾ This signal may be switched either to the front connector or to the rear I/O adapter CCT-RIO.

The upper green/yellow dual-LED signals 1Gbit/s when lit yellow, 100Mbit/s when lit green, and 10Mbit/s when off. The lower green LED indicates LINK established when continuously on, and data transfer (activity) when blinking. If the lower green LED is permanently off, no LINK is established.

Internal Connectors

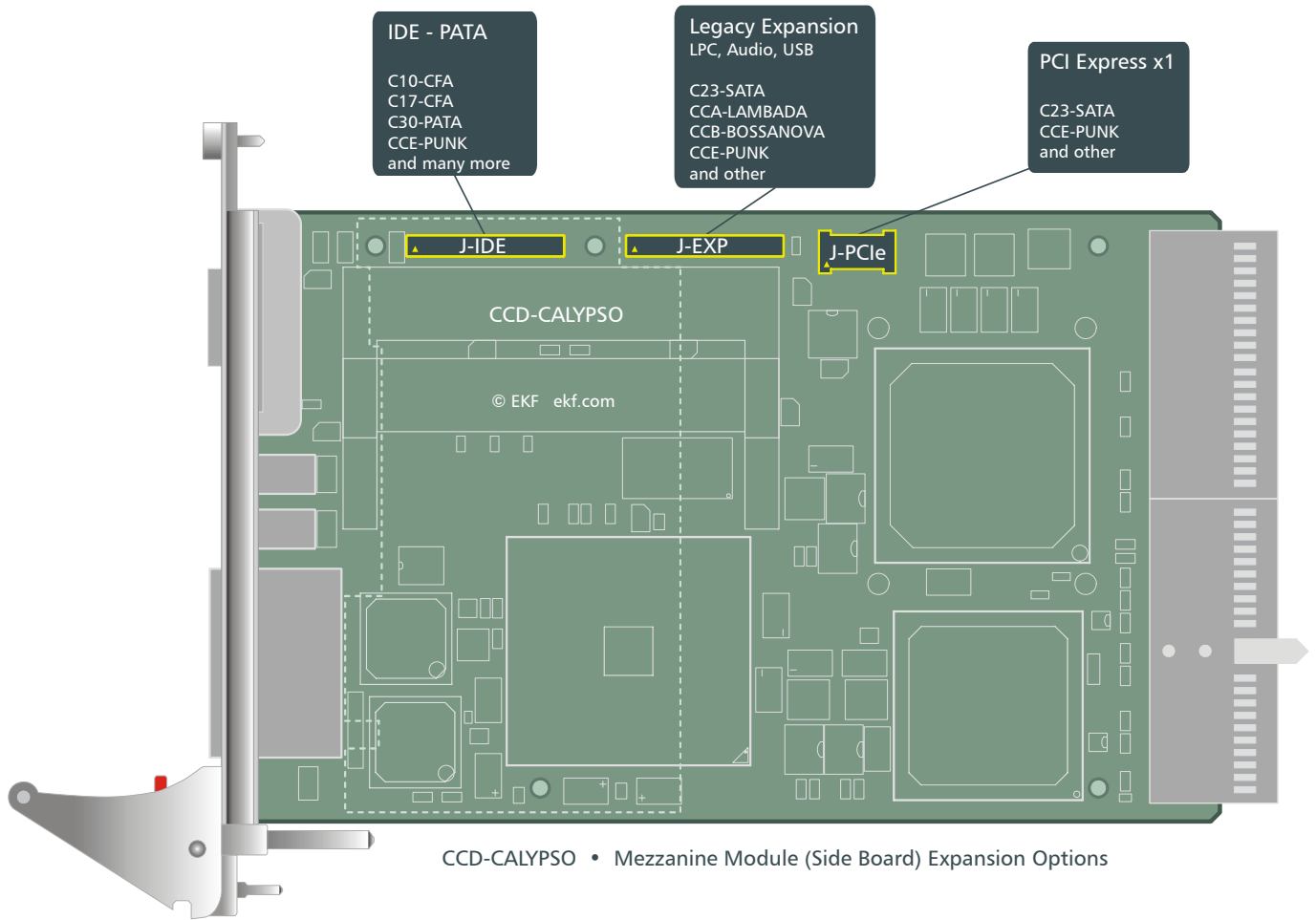

Mezzanine Expansion Connectors

Expansion Interface Header PEXP

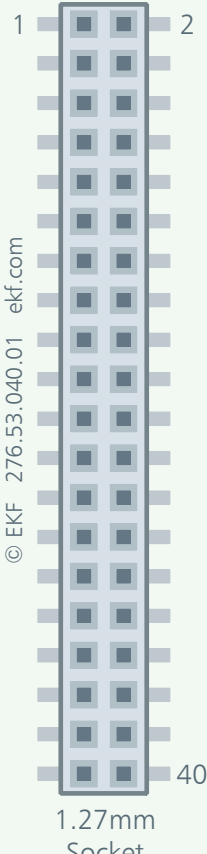
PEXPT/PEXPB				
	GND	1	2	+3.3V
	PCI_CLK	3	4	PCI_RST#
	LPC_AD0	5	6	LPC_AD1
	LPC_AD2	7	8	LPC_AD3
	LPC_FRM#	9	10	LPC_DRQ#
	GND	11	12	+3.3V
	SERIRQ	13	14	EXP_PME#
	EXP_SMI#	15	16	SIO_CLK14
	FWH_ID0	17	18	FWH_INIT#
	ICH_RCIN#	19	20	ICH_A20GATE
	GND	21	22	+5V
	USB_EXP_P2-	23	24	USB_EXP_P1-
	USB_EXP_P2+	25	26	USB_EXP_P1+
	USB_EXP_OC#	27	28	H_DBRESET#
	SIO_GPIO16	29	30	SIO_GPIO17
	GND	31	32	+5V
	AC97_SDOUT	33	34	AC97_SDIN0
	AC97_RST#	35	36	AC97_SYNC
	AC97_BITCLK	37	38	AC97_SDIN1
	SPEAKER	39	40	+12V/+VCCRTC ¹⁾

¹⁾ This pin is connected to +12V via a 0-ohm jumper (default on rev. 2 or higher). Alternatively it connects to +VCCRTC via a diode (default on revision 0 or 1 boards).

The expansion interface header is available on both sides of the board, top and bottom, in order to provide attachment of the CCA-LAMBADA either to the left or to the right side of the CCD-CALYPSO.

WARNING: Neither the +3.3V pin, nor the +5V pin, nor the +12V pin are protected against a short circuit situation! This connector therefore should be used only for attachment of an expansion board like CCA-LAMBADA. The maximum current flowing across these pins should be limited to 2A per power rail.

ATA/IDE Header PIDE

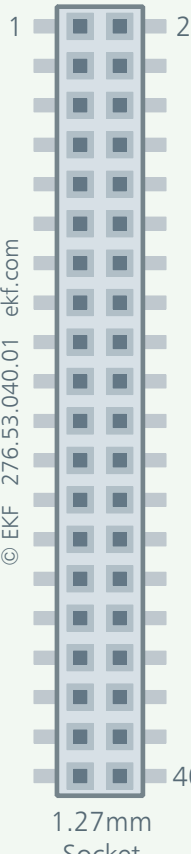
PIDET/PIDEB				
 <p>© EKF 276.53.040.01 ekf.com</p>	IDE_RST#	1	2	GND
	IDE_D07	3	4	IDE_D08
	IDE_D06	5	6	IDE_D09
	IDE_D05	7	8	IDE_D10
	IDE_D04	9	10	IDE_D11
	IDE_D03	11	12	IDE_D12
	IDE_D02	13	14	IDE_D13
	IDE_D01	15	16	IDE_D14
	IDE_D00	17	18	IDE_D15
	GND	19	20	+3.3V
	IDE_DREQ	21	22	+3.3V
	IDE_IOW#	23	24	GND
	IDE_IOR#	25	26	GND
	IDE_IORDY	27	28	+5V
	IDE_DACK#	29	30	+5V
	IDE_IRQ (INT 15)	31	32	GND
	IDE_A1	33	34	IDE_CBLID#
	IDE_A0	35	36	IDE_A2
	IDE_CS1#	37	38	IDE_CS3#
	IDE_ACT#	39	40	GND

Like the expansion interface header the IDE connector is also available on both sides of the board.

WARNING: Neither the +3.3V pin, nor the +5V pin are protected against a short circuit situation! This connector therefore should be used only for attachment of the C10-CFA adapter or an expansion board like CCA-LAMBADA. The maximum current flowing across these pins should be limited to 2A per power rail.



C13-RD Front Panel CF Card Slot



C17-CFA Bottom Mount CF Card Adapter

PCI Express Expansion Header PPCIE

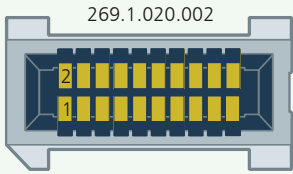
PPCIE				
	GND	1	2	GND
	+5V	3	4	+3.3V
	+5V	5	6	+3.3V
	GND	7	8	GND
	PE_CLKP	9	10	PE_RST#
	PE_CLKN	11	12	PE_WAKE#
	GND	13	14	GND
	PE_1TP	15	16	PE_1RP
	PE_1TN	17	18	PE_1RN
	GND	19	20	GND

The PCI Express expansion interface header is available on the top side of the board.

WARNING: Neither the +3.3V pin, nor the +5V pin are protected against a short circuit situation! The maximum current flowing across these pins should be limited to 2A per power rail.



High Speed Expansion Connector



CCD-CALYPSO w. C23-SATA Side Board

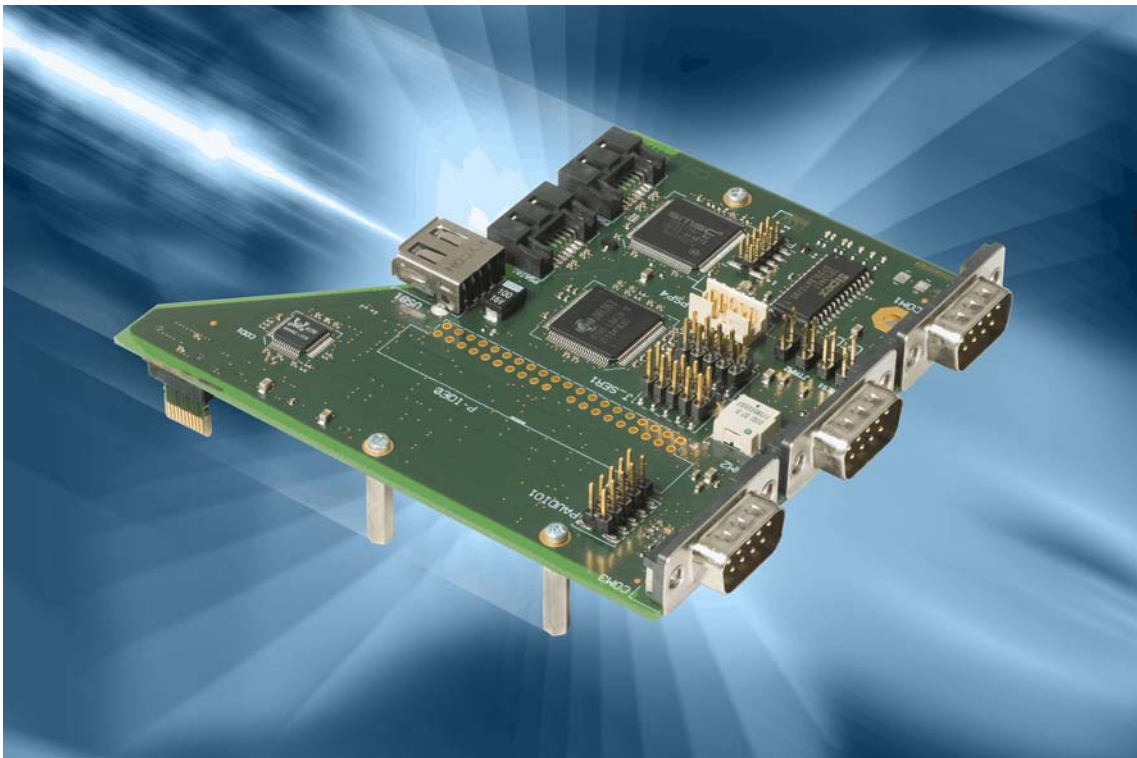

C23-SATA Side Board - PCIe Based

Speaker Header JSPK



WARNING: The +5V pin is protected against a short circuit situation by a 0.1A PolySwitch. The JSPK connector should be used exclusively for direct attachment of a dynamic speaker device. When connecting to the input of a sound card, most likely a short-circuit situation will occur between the +5V pin of the JSPK connector and the GND pin of the audio-card input, which could cause permanent damage to the CCD-CALYPSO and the audio board, despite the PolySwitch resettable fuse. A workaround to this would be to place a 1k resistor across pin 1 and pin 2 of the JSPK connector, and strapping a single wire cable from JSPK pin 2 to the audio input.

System Reset Header JRST

The jumper JRST is used to perform a manually system reset. By default JRST is connected with a short cable to a micro switch located within the front panel handle. The switch performs a system reset by short-circuiting the pins 1 and 3 of JRST.

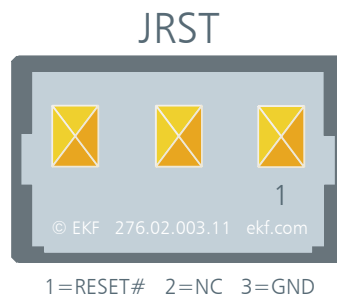

PLD Programming Header ISPCON

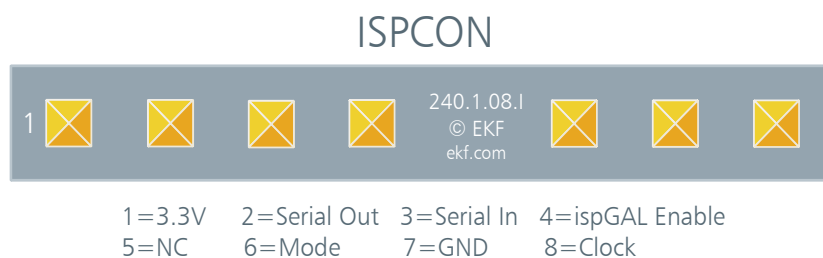

Note: The ISPCON is not stuffed. Its footprint is situated at the bottom side of the board.

Processor Debug Header PITP

PITP	
1	TDI
2	TMS
3	TRST#
4	NC
5	TCK
6	NC
7	TDO
8	BCLKN
9	BCLKP
10	GND
11	FBO
12	RST#
13	BPM5#
14	GND
15	BPM4#
16	GND
17	BPM3#
18	GND
19	BPM2#
20	GND
21	BPM1#
22	GND
23	BPM0#
24	DBA#
25	DBR#
26	VTAP
27	V _{TT}
28	V _{TT}

Note: The Debug Header is situated at the bottom side of the board.

CompactPCI J1

#J1	A	B	C	D	E
25	5V	REQ64# ²⁾	ENUM# ¹⁾	3.3V	5V
24	AD1	5V	V(I/O)	AD0	ACK64# ²⁾
23	3.3V	AD4	AD3	5V	AD2
22	AD7	GND	3.3V	AD6	AD5
21	3.3V	AD9	AD8	M66EN ³⁾	C/BE0#
20	AD12	GND	V(I/O)	AD11	AD10
19	3.3V	AD15	AD14	GND	AD13
18	SERR# ¹⁾	GND	3.3V	PAR	C/BE1#
17	3.3V	IPMB SCL ⁴⁾	IPMB SDA ⁴⁾	GND	PERR# ¹⁾
16	DEVSEL# ¹⁾	GND	V(I/O)	STOP# ¹⁾	LOCK# ¹⁾
15	3.3V	FRAME# ¹⁾	IRDY# ¹⁾	GND ⁵⁾	TRDY# ¹⁾
14	KEY AREA				
13					
12					
11	AD18	AD17	AD16	GND	C/BE2#
10	AD21	GND	3.3V	AD20	AD19
9	C/BE3#	GND ⁵⁾	AD23	GND	AD22
8	AD26	GND	V(I/O)	AD25	AD24
7	AD30	AD29	AD28	GND	AD27
6	REQ# ¹⁾	GND	3.3V	CLK	AD31
5	BRSVP1A5 ⁵⁾	BRSVP1B5 ⁵⁾	RST#	GND	GNT#
4	IPMB PWR	GND	V(I/O)	INTP ¹⁾	INTS ¹⁾
3	INTA# ¹⁾	INTB# ¹⁾	INTC# ¹⁾	5V	INTD# ¹⁾
2	TCK ⁵⁾	5V	TMS ⁵⁾	TDO ⁵⁾	TDI ⁵⁾
1	5V	-12V	TRST# ⁵⁾	+12V	5V

¹⁾ This pin is pulled up with 1kΩ to V(I/O). Other pull up resistor values (e.g. 2.7kΩ for V(I/O)=+3.3V) are available on request.

²⁾ This pin is not used on CCD-CALYPSO, but pulled up with 1kΩ to V(I/O). Other pull up resistor values on request.

³⁾ This pin is fixed to GND on CCD-CALYPSO to force 33MHz operation since 66MHz operation is not supported.

⁴⁾ This pin is pulled up with 2.4k to J1 pin A4.

⁵⁾ This pin is not connected.

CompactPCI J2

#J2	A	B	C	D	E
22	GA4 ⁵⁾	GA3 ⁵⁾	GA2 ⁵⁾	GA1 ⁵⁾	GA0 ⁵⁾
21	CLK6	GND	RSV NC1_MX2-	RSV NC1_MX3-	RSV NC1_MX3+
20	CLK5	GND	RSV NC1_MX2+	GND	RSV NC1_MX0+
19	GND	GND	RSV NC1_MX1-	RSV NC1_MX1+	RSV NC1_MX0-
18	BRSVP2A18 VGA_RED	BRSVP2B18 VGA_GREEN	BRSVP2C18 VGA_HSYNC	GND	BRSVP2E18 PXI_TRIG6 ³⁾ VGA_VSYNC
17	BRSVP2A17 VGA_BLUE	GND	PRST# ¹⁾	REQ6# ¹⁾	GNT6#
16	BRSVP2A16 PXI_TRIG1 ³⁾ +VCCRTC ⁸⁾	BRSVP2B16 PXI_TRIG0 ³⁾ DDC_SCL ²⁾	DEG# ¹⁾	GND	BRSVP2E16 PXI_TRIG7 ³⁾ DDC_SDA ²⁾
15	BRSVP2A15	GND	FAL# ¹⁾	REQ5# ¹⁾	GNT5#
14	AD35 ¹⁾ SATA_2RN	AD34 ¹⁾ SATA_2RP	AD33 ¹⁾ SATA_ACT#	GND	AD32 ¹⁾ GND
13	AD38 ¹⁾ GND	GND	V(I/O)	AD37 ¹⁾ SATA_2TP	AD36 ¹⁾ SATA_2TN
12	AD42 ¹⁾ SATA_1RN	AD41 ¹⁾ SATA_1RP	AD40 ¹⁾	GND	AD39 ¹⁾ GND
11	AD45 ¹⁾ GND	GND	V(I/O)	AD44 ¹⁾ SATA_1TP	AD43 ¹⁾ SATA_1TN
10	AD49 ¹⁾ SATA_ORN	AD48 ¹⁾ SATA_ORP	AD47 ¹⁾	GND	AD46 ¹⁾ GND
9	AD52 ¹⁾ GND	GND	V(I/O)	AD51 ¹⁾ USB_P7P	AD50 ¹⁾ USB_P7N
8	AD56 ¹⁾ SATA_OTN	AD55 ¹⁾ SATA_OTP	AD54 ¹⁾ GND	GND COM1_DSR#	AD53 ¹⁾ COM1_TXD
7	AD59 ¹⁾ COM1_DTR#	GND COM1_CTS#	V(I/O) COM1_RXD	AD58 ¹⁾ COM1_RTS#	AD57 ¹⁾ COM1_DCD#
6	AD63 ¹⁾ USB_P3P	AD62 ¹⁾ USB_P3N	AD61 ¹⁾ USB_P4P	GND USB_OC34#	AD60 ¹⁾ USB_P4N
5	C/BE5# ¹⁾ +5V/1.5A ⁴⁾	GND (64EN#) ¹⁾	V(I/O)	C/BE4# ¹⁾ MS_DATA	PAR64 ¹⁾ MS_CLK
4	V(I/O)	BRSVP2B4 ⁶⁾ +5V/1.5A ⁴⁾	C/BE7# ¹⁾ KB_DATA	GND	C/BE6# ¹⁾ KB_CLK
3	CLK4	GND	GNT3#	REQ4# ¹⁾	GNT4#
2	CLK2	CLK3	SYSEN# ⁷⁾	GNT2#	REQ3# ¹⁾
1	CLK1	GND	REQ1# ¹⁾	GNT1#	REQ2# ¹⁾

- 1) This pin is pulled up with 1kΩ to V(I/O). Other pull up resistor values (e.g. 2.7kΩ for V(I/O)= +3.3V) are available on request.
- 2) This pin is pulled up via a QuickSwitch with 2.7kΩ to +5V.
- 3) This pin is pulled up with 10kΩ to +5V.
- 4) This pin is protected by a resettable PolySwitch fuse.
- 5) This pin is not connected.
- 6) This pin is connected only in the rear I/O configuration.
- 7) This pin is pulled up with 10kΩ to +3.3V.
- 8) This pin is connected to VCCRTC via a diode.
- 9) Pin positions printed blue: Rear I/O options.

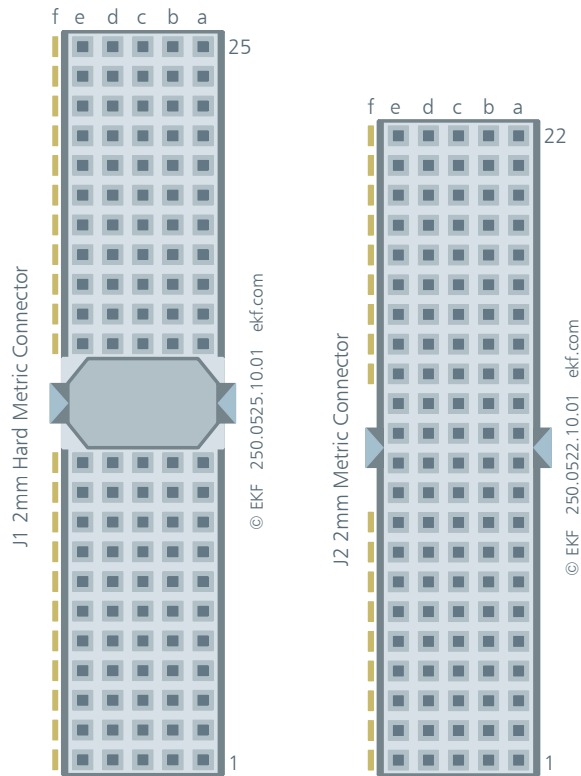

Literature

Theme	Document Title	Origin
<i>CompactPCI</i>	<i>CompactPCI</i> Specification, PICMG 2.0 R3.0, Oct. 1, 1999	www.picmg.org
PCI Express	PCI Express® Base Specification 1.1	www.pcisig.com
PCI Local Bus	PCI 2.2/2.3/3.0 Standards PCI SIG	www.pcisig.com
Ethernet	IEEE Std 802.3, 2000 Edition	standards.ieee.org
USB	Universal Serial Bus Specification	www.usb.org
CompactFlash	CF+ and CompactFlash Specification Revision 3.0	www.compactflash.org

Appendix

Mechanical Drawings

The following drawing shows the positions of mounting holes and expansion connectors on the CCD-CALYPSO.

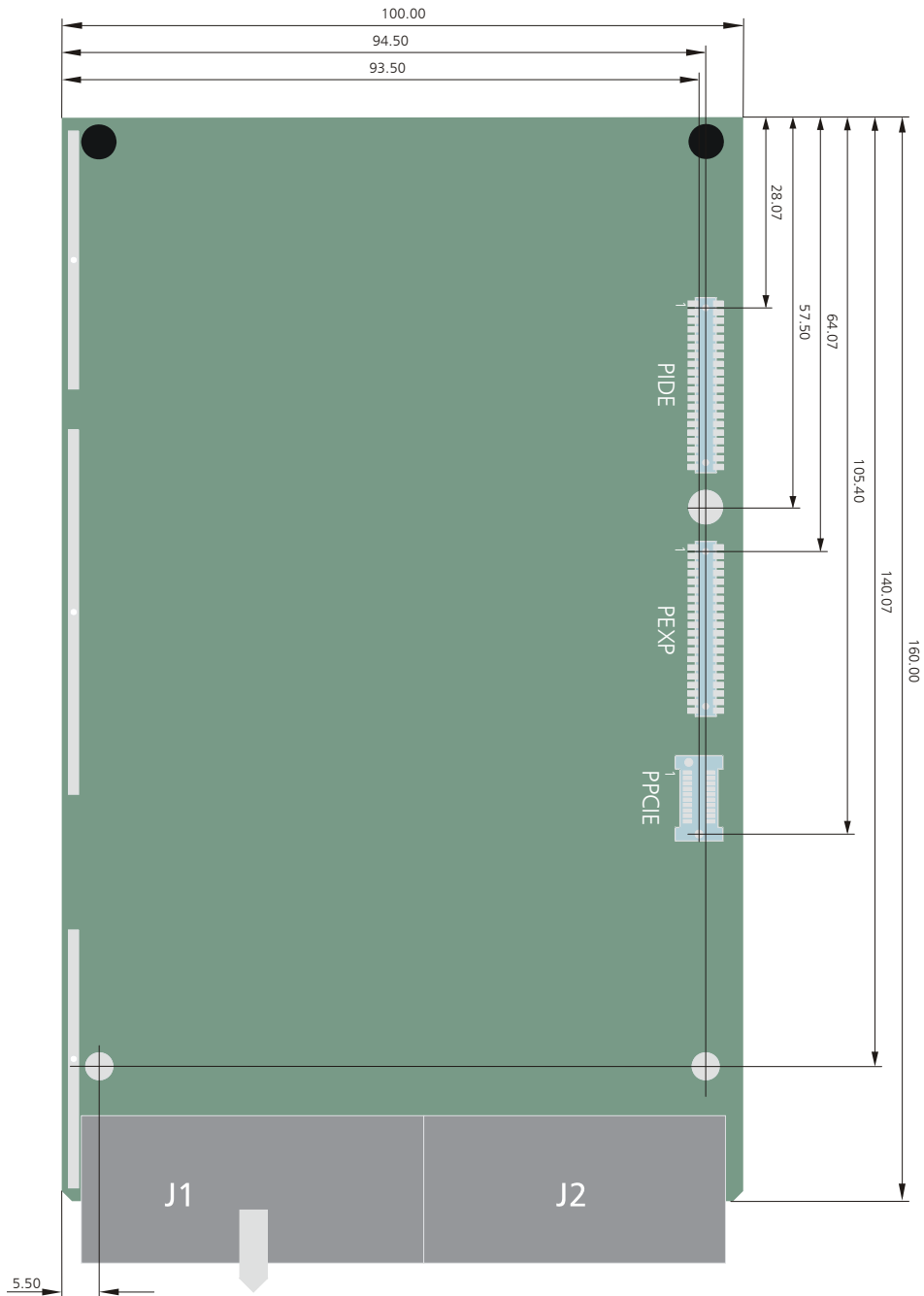

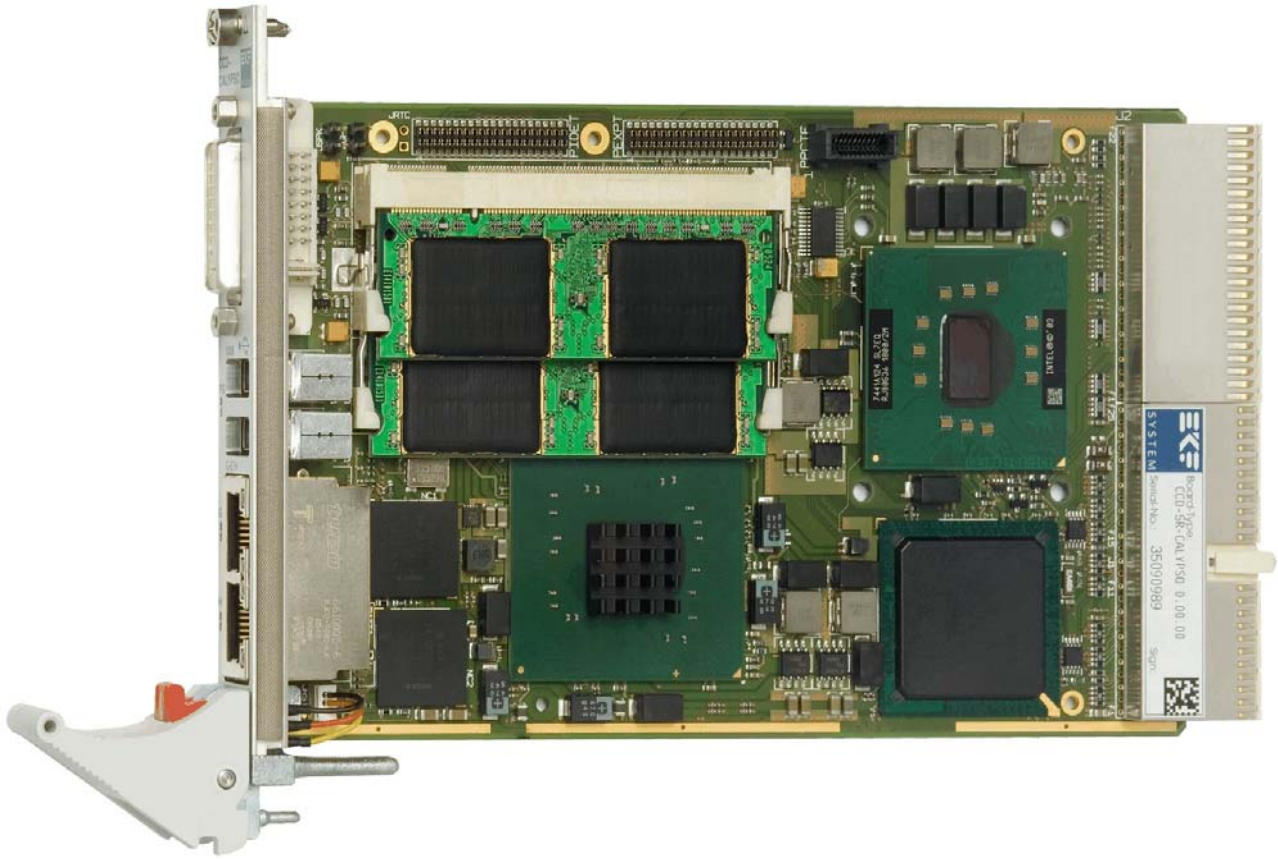

Top View CCD-CALYPSO Shown w/o Heatsink



EKF BluLine Small CPCI Systems



EKF Elektronik GmbH
Philipp-Reis-Str. 4
59065 Hamm
Germany



Phone +49 (0)2381/6890-0
Fax +49 (0)2381/6890-90
Internet www.ekf.com
E-Mail sales@ekf.com