



Product Information

SE2-MOOD • *CompactPCI® Serial* • Dual M.2 NVMe (PCIe) SSD

Document No. 8140 • 29 May 2017



General

The SE2-MOOD is a peripheral slot card for CompactPCI® Serial systems, equipped with three M.2 sockets for SSD (Solid-State Drive) modules.

Two of the M.2 sockets are suitable for NVMe type SSD modules, with a PCIe x4 Gen3 interface for superior data transfer rates. When used as main mass storage devices in a system, the NVMe SSDs can speed up the overall system performance dramatically.

The third (optional) M.2 connector can accommodate a classic AHCI SATA style SSD, used e.g. as backup drive or legacy systems boot device.

With respect to the NVMe sockets, the SE2-MOOD is suitable for all NGFF SSD module sizes defined by the M.2 specification up to the 22110 form factor (SATA socket max. 2280). In order to avoid mix-up, the M.2 sockets are mechanically coded. The NVMe module sockets are provided with an M-key, and the SATA module connector features a B-key, according to the PCI Express® M.2 Specification (PCI-SIG).

For optimum NVMe SSD module performance, a PCI Express® x8 enabled backplane slot would be required (CompactPCI® Serial fat pipe slot). In addition, SATA backplane support is needed for the SATA SSD module.



Feature Summary

General

- ▶ PICMG® CompactPCI® Serial standard (CPCI-S.0)
- ▶ Single size Eurocard 3U 4HP 100x160mm²
- ▶ Suitable for CompactPCI® Serial peripheral slot (PCI Express® & SATA enabled)
- ▶ CompactPCI® Serial fat pipe slot PCIe x8 or at least peripheral slot PCIe x4 recommended
- ▶ CompactPCI® Serial backplane connectors P1& P2 for PCI Express® x8 and SATA

M.2 NVMe

- ▶ Designed according to PCI-SIG® PCI Express® M.2 Specification (aka NGFF)
- ▶ Dual M.2 NVMe SSD module sockets (M-key) pin-out according to 'Socket 3 PCIe x4 SSD'
- ▶ M.2 NVMe module size 22110, 2280, 2260, 2242, 2230, 4.2H (accepts double-sided modules)
- ▶ On-board PCI Express® Gen3 (8GTps) packet switch 3 ports 16 lanes for maximum NVMe performance via both M.2 NVMe module sockets simultaneously
- ▶ Maximum performance with backplane slot PCIe x8 Gen2/3
- ▶ Primarily for NVMe protocol based M.2 SSD modules
- ▶ Suitable also for OEM legacy AHCI protocol based M.2 modules (PCIe SATA controller)
- ▶ 2TB NVMe modules available as of current for a total of 4TB
- ▶ Individual drive configuration or soft RAID operation
- ▶ Boot capability requires NVMe enabled BIOS for NVMe protocol modules
- ▶ Recommended usage as high speed mass storage for demanding applications

M.2 SATA (Option)

- ▶ M.2 SATA SSD module socket (B-key) pin-out according to 'Socket 2 SATA SSD'
- ▶ M.2 SATA module size 2280, 2260, 2242, 2230, 4.2H (accepts double-sided module)
- ▶ Requires SATA enabled backplane slot
- ▶ SATA 6G redriver circuit on-board for optimum signal integrity
- ▶ Recommended for additional medium speed mass storage and backup

Feature Summary

Front Panel IO (Option)

- ▶ Gigabit Ethernet (RJ45) - requires GbE enabled backplane slot (passed through from P6)
- ▶ USB 3.0 (Type-A) - requires USB enabled backplane slot (passed through from P1)

Regulatory

- ▶ Designed & manufactured in Germany
- ▶ Certified quality management according to ISO 9001
- ▶ Long term availability
- ▶ Rugged solution (coating, sealing, underfilling on request)
- ▶ RoHS compliant
- ▶ Operation temperature 0°C to +70°C (commercial temperature range)
- ▶ Operation temperature -40°C to +85°C (industrial temperature range) on request
- ▶ Storage temperature -40°C to +85°C, max. gradient 5°C/min
- ▶ Humidity 5% ... 95% RH non condensing
- ▶ Altitude -300m ... +3000m
- ▶ Shock 15g 0.33ms, 6g 6ms
- ▶ Vibration 1g 5-2000Hz
- ▶ MTBF 157.5 years
- ▶ EC Regulations EN55022, EN55024, EN60950-1 (UL60950-1/IEC60950-1)

Please note: M.2 modules must be ordered separately

Block Diagram

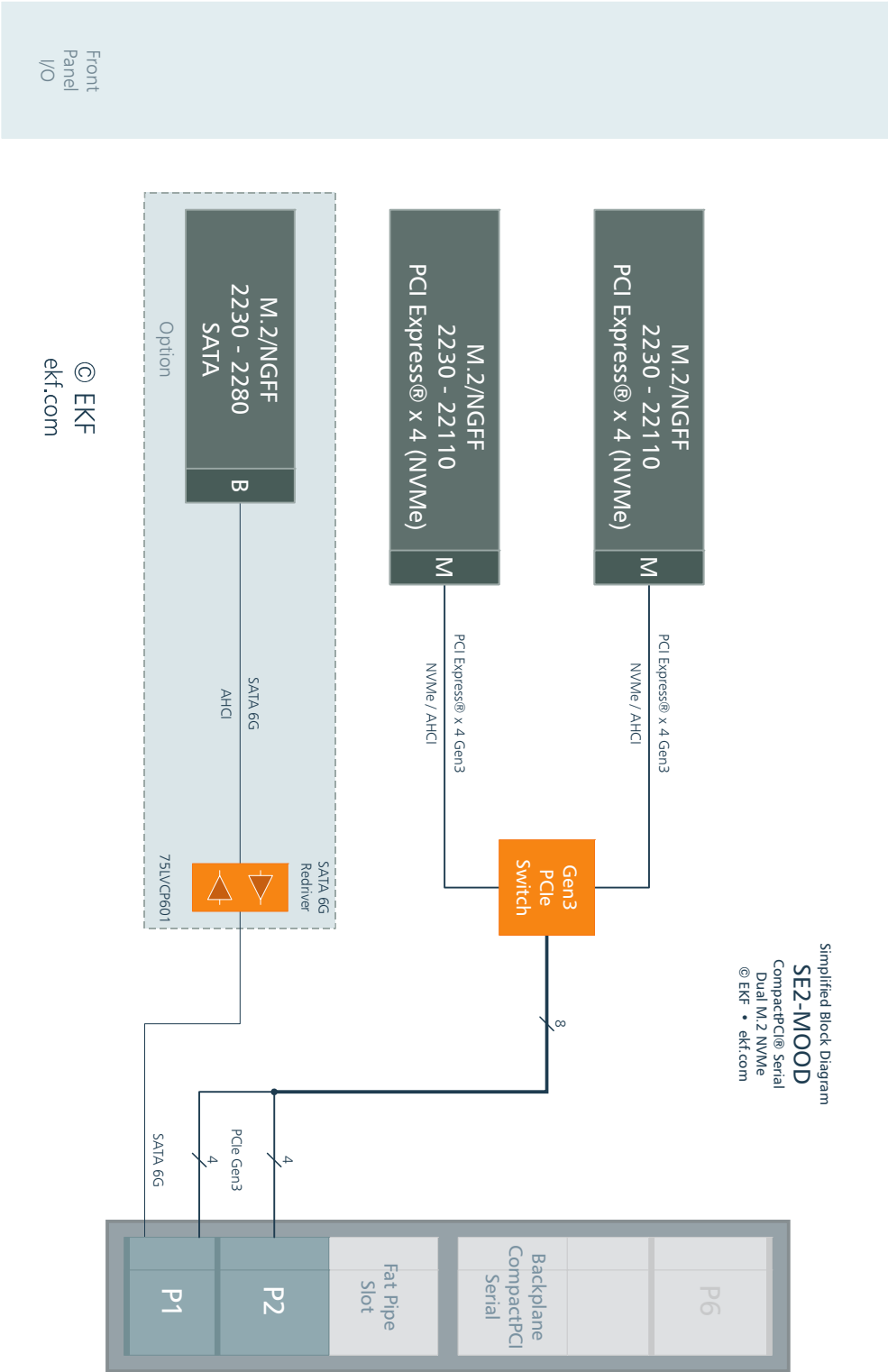

Front Panel I/O

© EKF
ekf.com

Optional Components

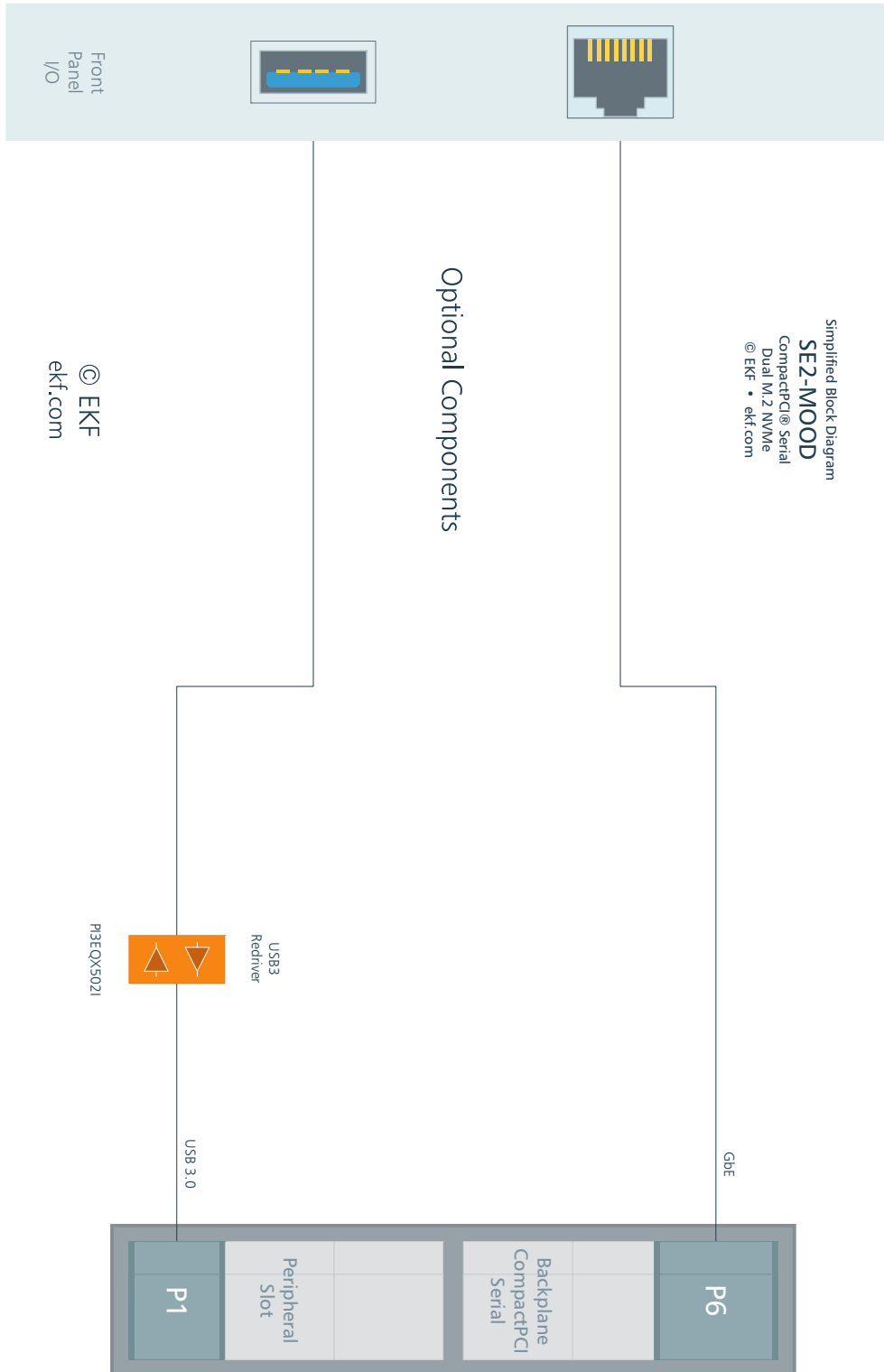

Component Orientation

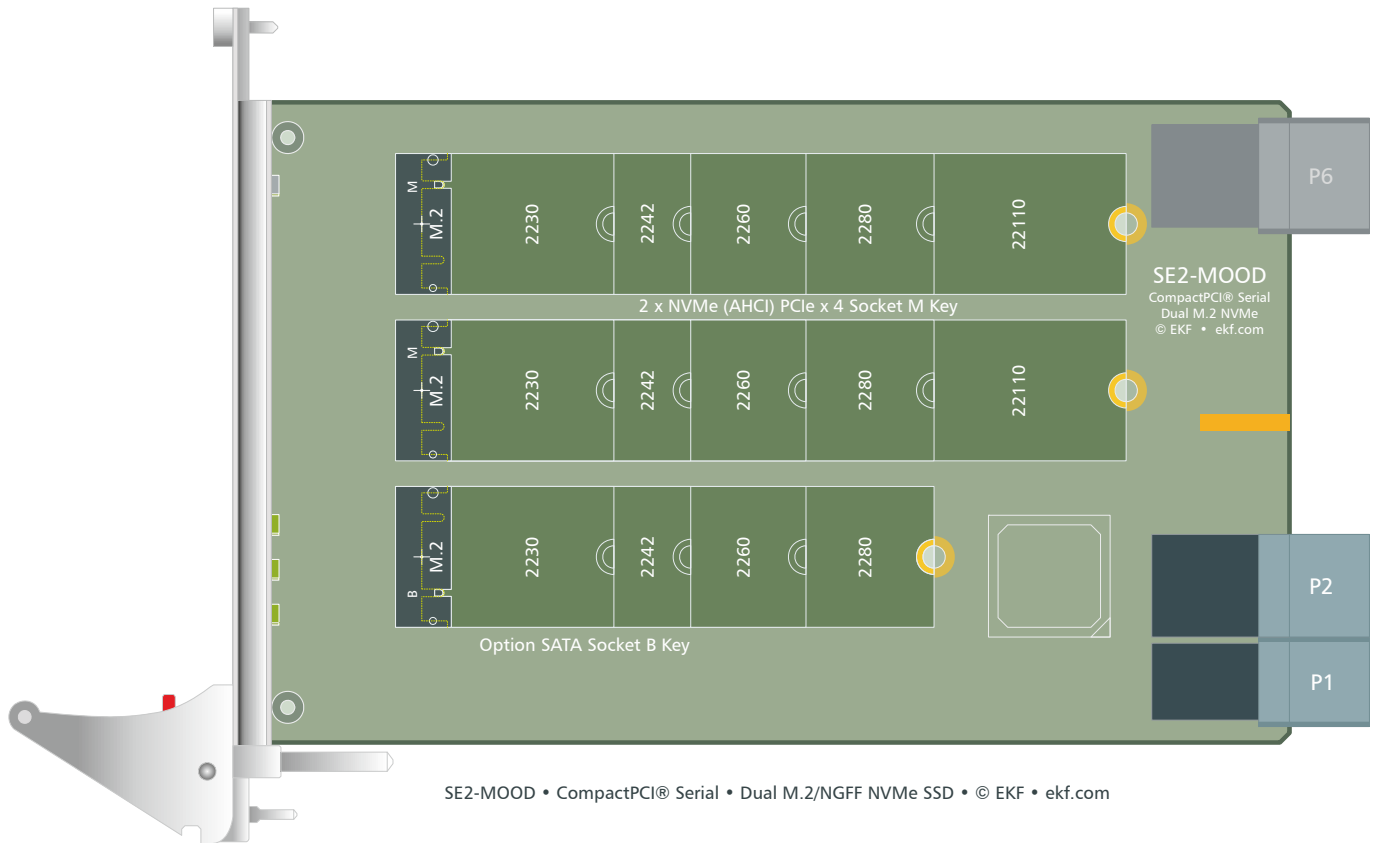

P6 is not populated by default. This connector can be provided on request for even more mechanical stability, e.g. railway applications. P6 is mandatory however together with the Gigabit Ethernet front panel jack option (see next page).

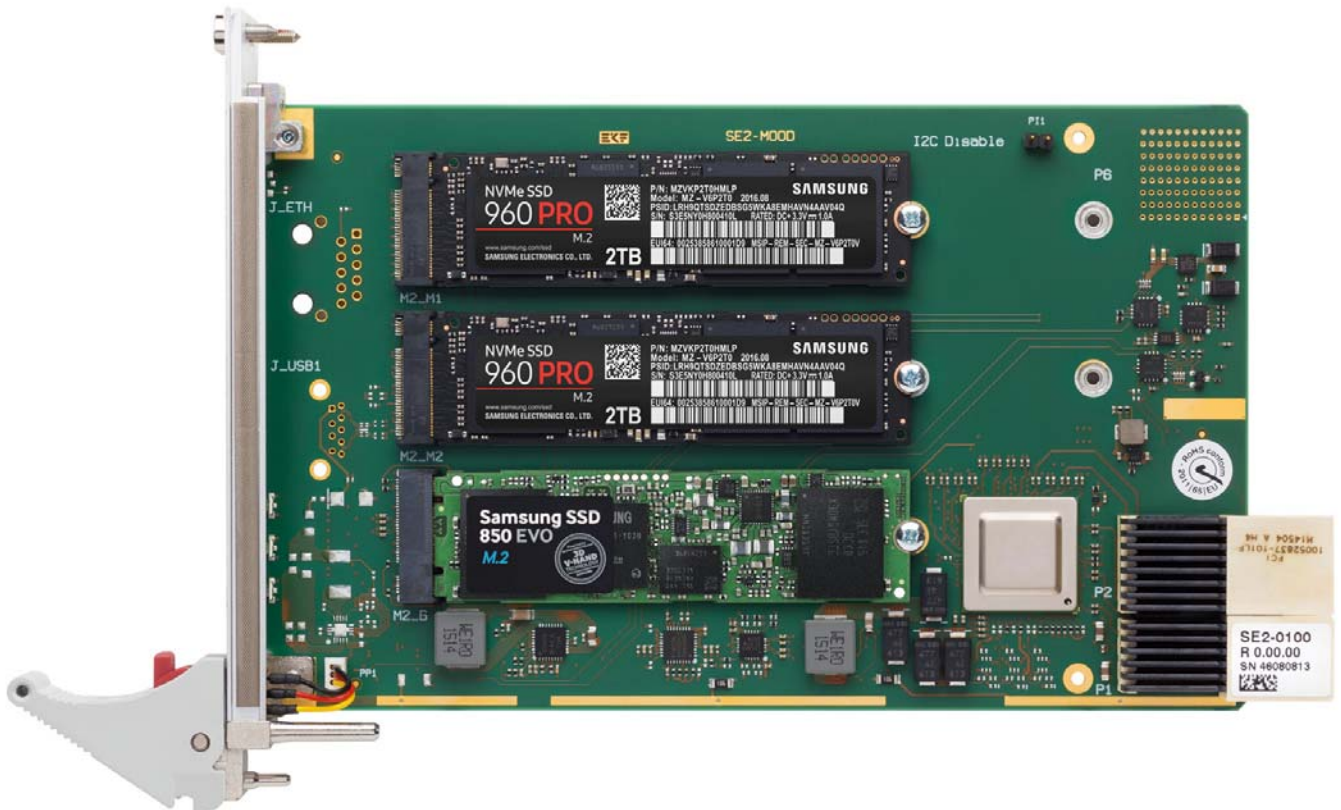
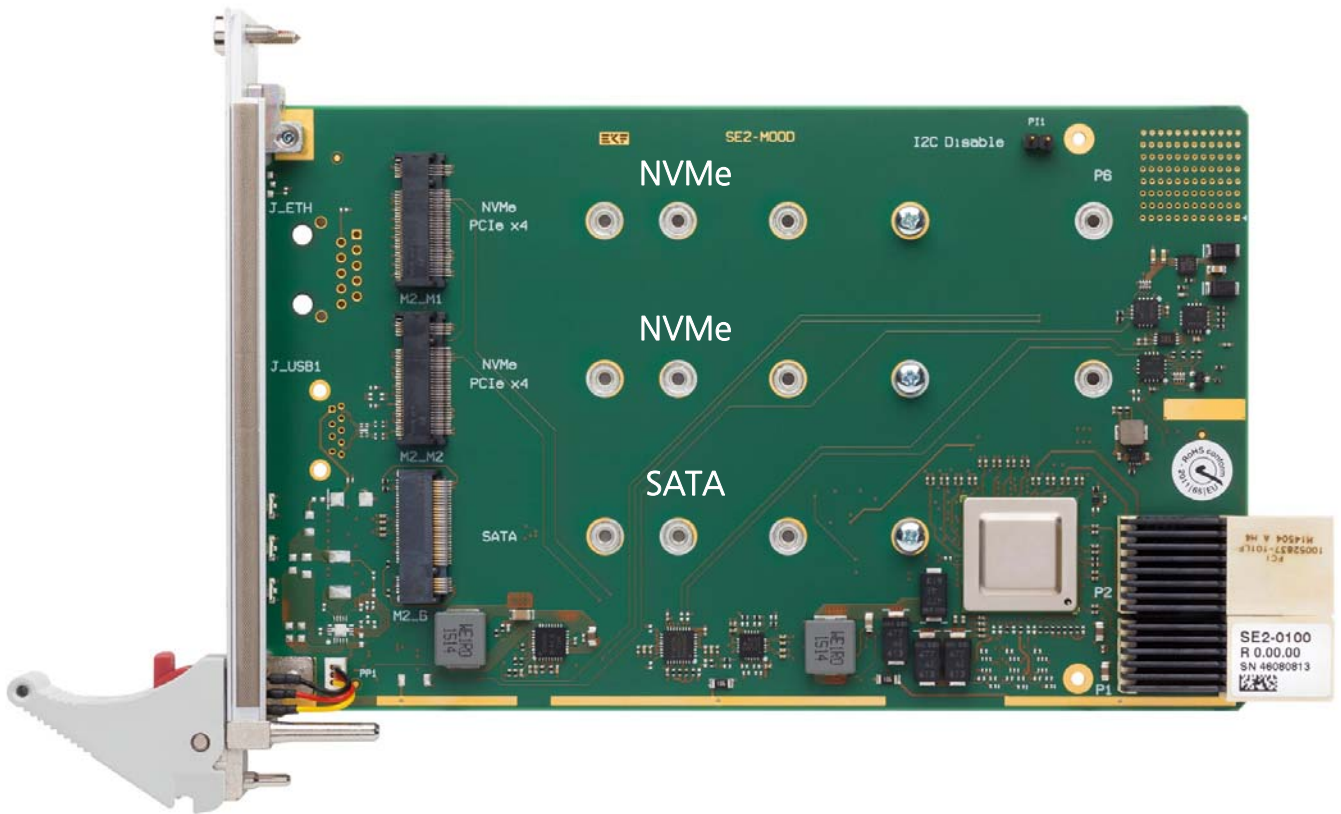

Optional F/P Components

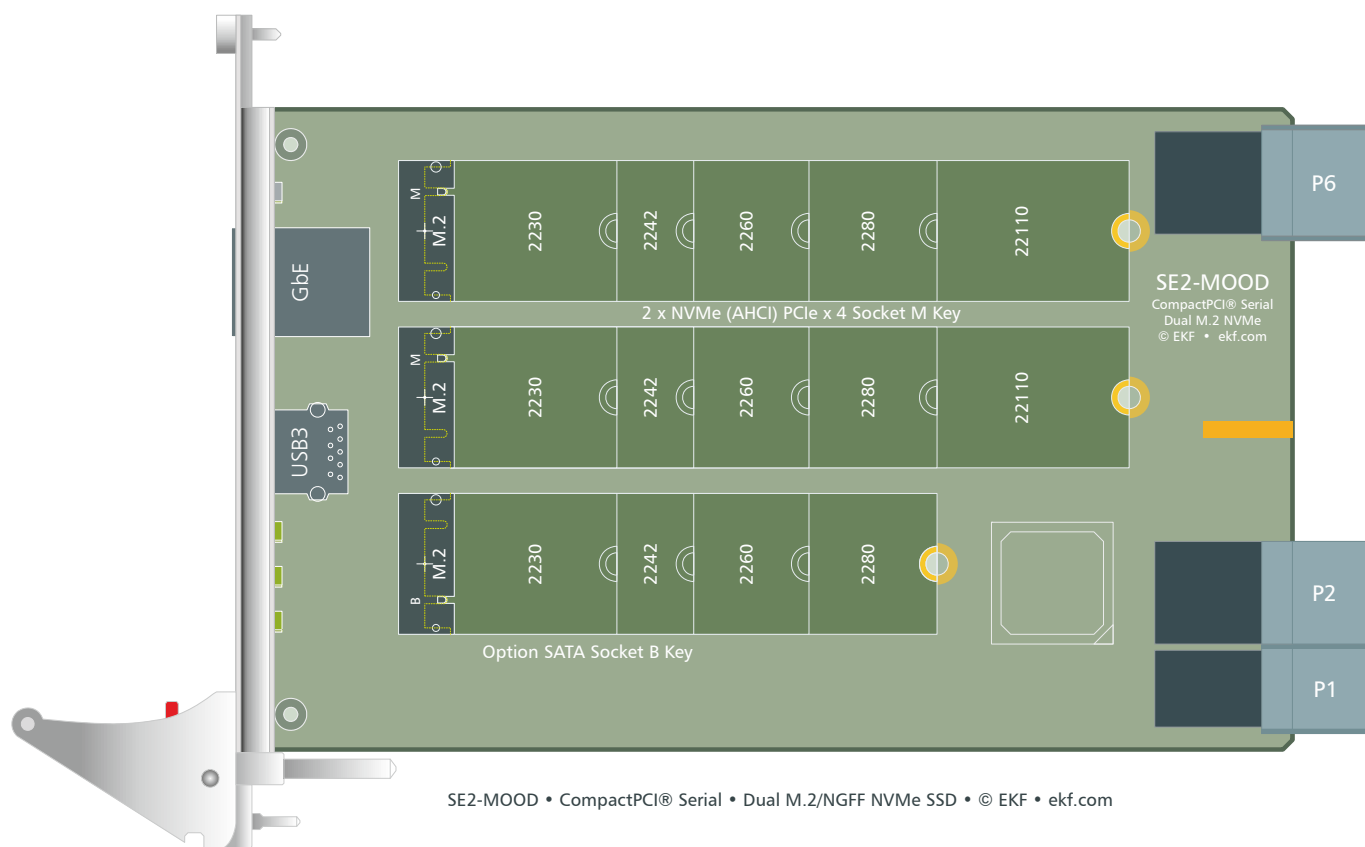

As an option, the SE2-MOOD can be equipped with an USB 3.0 front panel connector. This USB port is sourced from the backplane connector P1 via an USB SuperSpeed redriver. The USB option requires an USB 3.0 enabled backplane slot.

As another option, the SE2-MOOD can be equipped with a Gigabit Ethernet RJ45 jack (internal magnetics). This port is wired to the backplane connector P6 without any redriver circuitry and therefore is not guaranteed for operation over the full external cable length. For Gigabit Ethernet usage a GbE enabled backplane slot would be required.

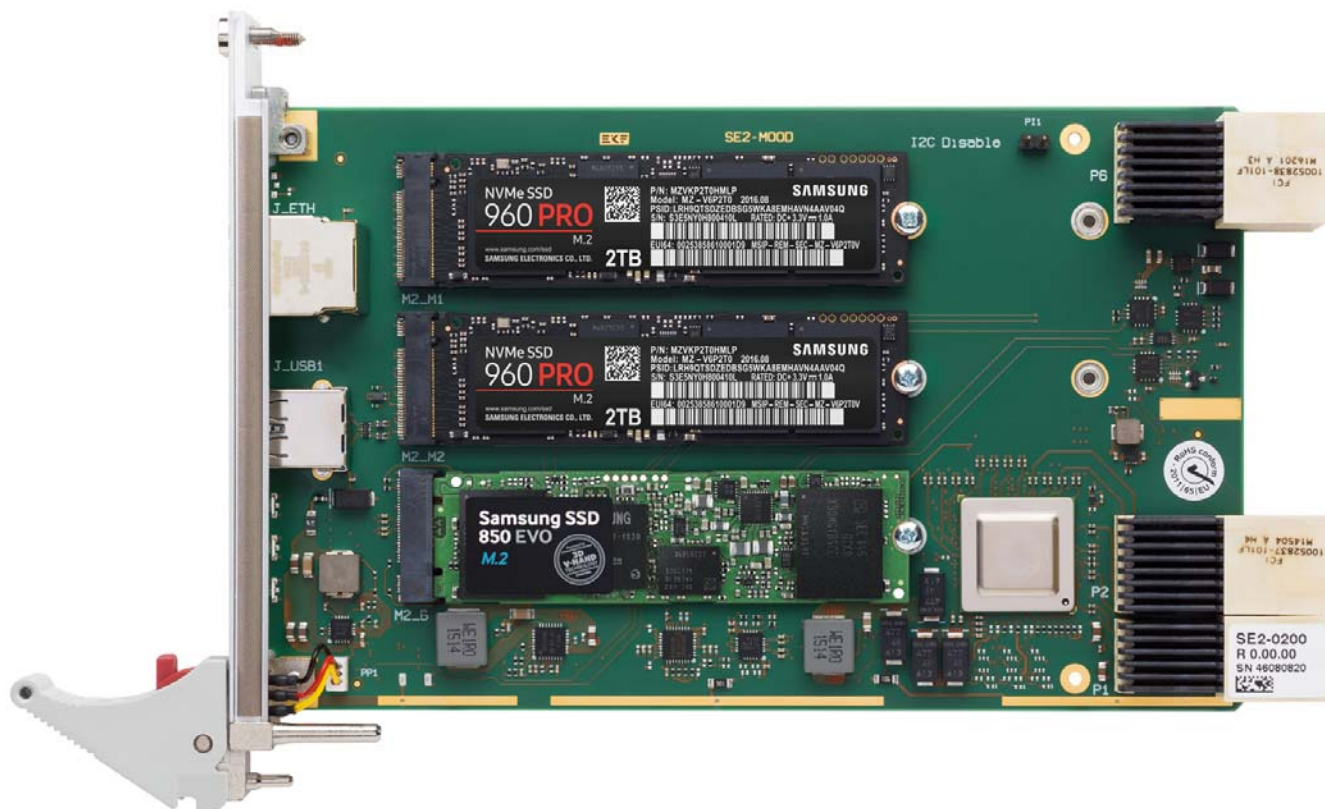

Front Panel

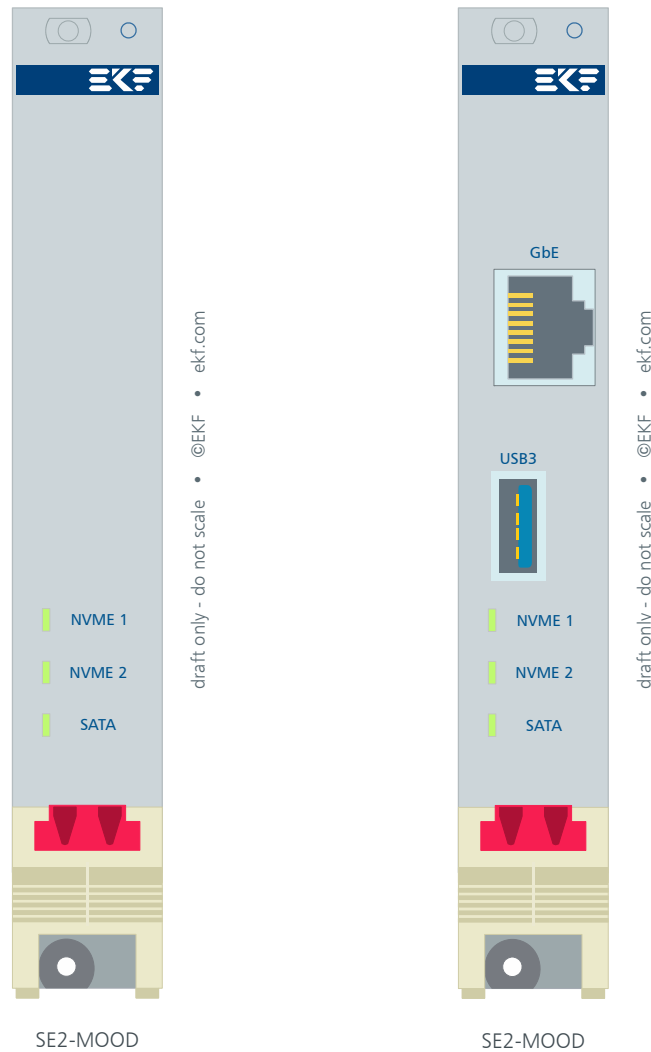

LED Function: Blink = Activity

F/P Connectors Available on Request

M.2 Connectors

The SE2-MOOD is provided with three M.2 module host connectors, which differ in mechanical keying and electrical pin-out. Mechanical details and pin-out configurations are described by the PCI-SIG 'PCI Express M.2 Specification'.

With respect to the SE2-MOOD, the B-key connector must be used for the SATA SSD, with a pin-out according to 'Socket 2 B+M SSD', and module dimensions from 'Type 2230 to 2280', either height option 'S2, D2, S3, D3, D5'. For operability of the SATA SSD, the SE2-MOOD must be inserted into an SATA enabled CompactPCI® backplane slot (please refer to diagrams 'Backplane Resources' e.g. www.ekf.com/s/sc3/img/sc3_backplane.pdf). The SATA channel is derived from the system slot CPU card. The maximum SATA data transfer rate 3G or 6G may depend on the particular CPU card and the backplane slot selected for the SE2-MOOD. An on-board SATA redriver is provided for optimum signal integrity.

Two M-key coded connectors are provided for PCIe x4 (NVMe) SSD modules. The pin-out complies with the 'Socket 3 M SSD Drive', with module dimensions from 'Type 2242 to 22110', either height option 'S2, D2, S3, D3, D5'. For operability of PCIe based SSDs, the SE2-MOOD must be inserted into a PCIe enabled CompactPCI® backplane slot (please refer to diagrams 'Backplane Resources' e.g. www.ekf.com/s/sc3/img/sc3_backplane.pdf). The PCIe link is established by the system slot CPU card. The maximum PCIe data transfer rate Gen2 (5GTps) or Gen3 (8GTps) may depend on the particular CPU card and the backplane slot selected for the SE2-MOOD. For optimum performance, a Gen3 x8 powered backplane slot (fat pipe slot) should be chosen for the SE2-MOOD. The on-board Gen3 PCIe packet switch establishes two independent PCIe x4 downstream links to the NVMe module connectors.

The PCIe x4 M.2 sockets allow considerable higher SSD I/O transfer rates (up to 32Gbps theoretically) compared to the SATA connector (up to 6Gbps). These M.2 drives therefore should be chosen as boot device and mass storage for maximum system performance. The SATA SSD can be used as additional storage or backup medium in such a configuration, or boot device in a legacy BIOS firmware environment.

M.2 NVMe and M.2 PCIe x4 are often used as synonyms. However, NVMe (NVM Express™ - non-volatile memory attached through the PCI Express® bus) is both an interface and also a command set or software protocol. Any recent operating system should incorporate NVMe drivers. In addition, the UEFI firmware (aka BIOS) should be verified in order to be able to boot from an NVMe device. This is true for EKF CPU cards from the SC2-PRESTO off.

There are also PCIe x4 based SSDs available which comply with the AHCI (SATA) protocol, for legacy systems. When ordering PCIe based SSD modules, be sure to choose the version which is most suitable for your application.

After insertion, an M.2 module must be locked manually by a screw, in order to withstand shock and vibration.

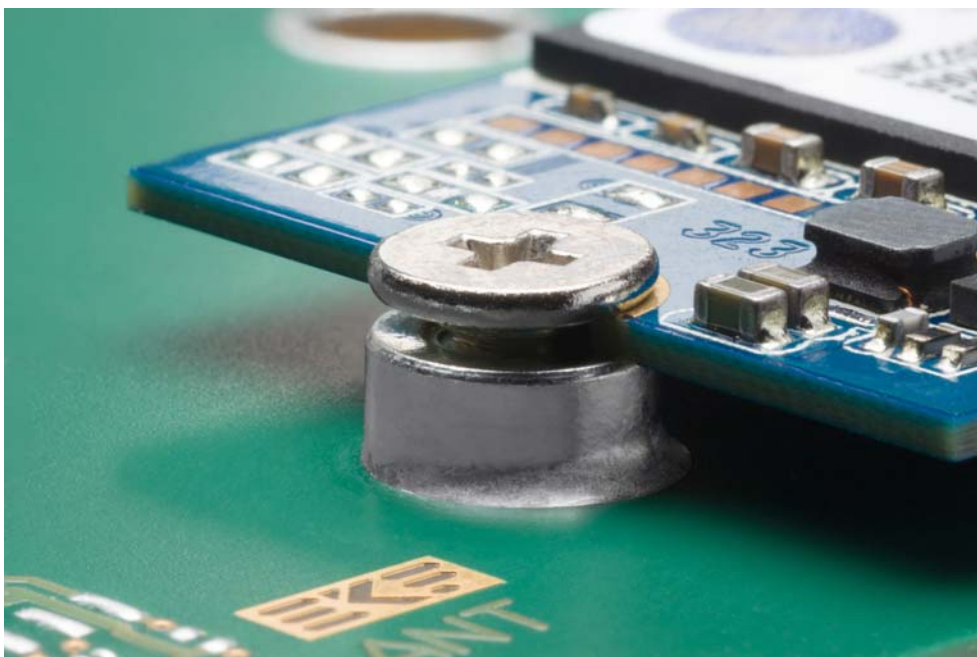

M.2 Module Fixation (Picture Similar)

Mounting Parts for M.2 SSD Modules

440.08.025.006	Screw M2.5 x 6mm (supplied together with board)
442.0.02502.5	Spacer sleeve M2.5 x 2.5mm (supplied together with board)
440.45.025.015	M2.5 PCB nut, bottom mount threaded inserts (populated on-board by default)

M.2 SATA

AHCI SATA			
M.2 B-Key • Pin 1 - 38			
EKF Part #255.50.1.2242.10			
CFG-3 *	1	2	+3.3V
GND	3	4	+3.3V
GND	5	6	NC
NC	7	8	NC
NC	9	10	DA/DSS
GND	11	12	B Key
B Key	13	14	B Key
B Key	15	16	B Key
B Key	17	18	B Key
B Key	19	20	NC
CFG-0 *	21	22	NC
NC	23	24	NC
NC	25	26	NC
GND	27	28	NC
NC	29	30	NC
NC	31	32	NC
GND	33	34	NC
NC	35	36	NC
NC	37	38	DEVSLP

* 10k pull-up +3.3V



AHCI SATA			
M.2 B-Key continued • Pin 39 - 75			
GND	39	40	NC
SATA B+ (SSD OUT)	41	42	NC
SATA B- (SSD OUT)	43	44	NC
GND	45	46	NC
SATA A- (SSD IN)	47	48	NC
SATA A+ (SSD IN)	49	50	NC
GND	51	52	NC
NC	53	54	NC
NC	55	56	NC
GND	57	58	NC
NC M-Key	59	60	NC M-Key
NC M-Key	61	62	NC M-Key
NC M-Key	63	64	NC M-Key
NC M-Key	65	66	NC M-Key
NC	67	68	NC
CFG-1 *	69	70	+3.3V
GND	71	72	+3.3V
GND	73	74	+3.3V
CFG-2 *	75		

* 10k pull-up +3.3V

M.2 PCIe x4

NVMe PCIe x4 M.2 M-Key • Pin 1 - 38 EKF Part #255.50.2.2242.10			
GND	1	2	+3.3V
GND	3	4	+3.3V
PETN3	5	6	NC
PETP3	7	8	NC
GND	9	10	LED1#
PERN3	11	12	+3.3V
PERP3	13	14	+3.3V
GND	15	16	+3.3V
PETN2	17	18	+3.3V
PETP2	19	20	NC
GND	21	22	NC
PERN2	23	24	NC
PERP2	25	26	NC
GND	27	28	NC
PETN1	29	30	NC
PETP1	31	32	NC
GND	33	34	NC
PERN1	35	36	NC
PERP1	37	38	NC





NVMe PCIe x4			
M.2 M-Key continued • Pin 39 - 75			
GND	39	40	NC
PETNO	41	42	NC
PETPO	43	44	NC
GND	45	46	NC
PERNO	47	48	NC
PERPO	49	50	PERST#
GND	51	52	CLKREQ#
REFCLKN	53	54	PEWAKE#
REFCLKP	55	56	RSV
GND	57	58	RSV
M-Key	59	60	M-Key
M-Key	61	62	M-Key
M-Key	63	64	M-Key
M-Key	65	66	M-Key
NC	67	68	RSV
NC	69	70	+3.3V
GND	71	72	+3.3V
GND	73	74	+3.3V
GND	75		

Front Panel Connectors (Option)

Available on request, the SE2-MOOD front panel can be provided with I/O connectors for Gigabit Ethernet (RJ45) and USB 3.0. Both data ports are passed through from the associated backplane connectors, P6 for Gigabit Ethernet, and P1 with respect to USB3 and USB2. For operability, the CompactPCI® Serial backplane resources of the chosen backplane slot must be available (please refer to diagrams 'Backplane Resources' e.g. www.ekf.com/s/sc3/img/sc3_backplane.pdf).

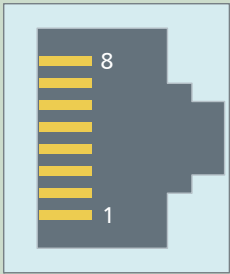
Usage of both I/O connectors is independent from the M.2 SSD mass storage devices. However, the USB connector may be useful for copying data from an SSD to an USB stick and vice versa. The Ethernet connector would allow to attach e.g. a NAS.

Gigabit Ethernet 270.01.08.6 • RJ45 Jack		
270.01.08.06  © EKF • ekf.com Draft - Do Not Scale	1	MDX0+
	2	MDX0-
	3	MDX1+
	4	MDX2+
	5	MDX2-
	6	MDX1-
	7	MDX3+
	8	MDX3-

USB 3.0 Standard Mount Receptacle • 270.23.09.1		
270.23.09.1 © EKF • ekf.com 	1	VBUS +5V 1.5Amax
	2	USB D-
	3	USB D+
	4	GND
	5	SS RX-
	6	SS RX+
	7	GND
	8	SS TX-
	9	SS TX+

Please contact sales@ekf.de before ordering.

CompactPCI® Serial Backplane Connectors P1/P2

P1 CompactPCI® Serial Peripheral Slot Backplane Connector												
EKF Part #250.3.1206.20.02 • 72 pos. 12x6, 14mm Width												
P1	A	B	C	D	E	F	G	H	I	J	K	L
6	GND	PE TX02+	PE TX02-	GND	PE RX02+	PE RX02-	GND	PE TX03+	PE TX03-	GND	PE RX03+	PE RX03-
5	PE TX00+	PE TX00-	GND	PE RX00+	PE RX00-	GND	PE TX01+	PE TX01-	GND	PE RX01+	PE RX01-	GND
4	GND	<i>USB2+</i>	<i>USB2-</i>	GND	PE CLK+	PE CLK-	GND	SATA TX+	SATA TX-	GND	SATA RX+	SATA RX-
3	<i>USB3 TX+</i>	<i>USB3 TX-</i>	GA0	<i>USB3 RX+</i>	<i>USB3 RX-</i>	GA1	<i>SATA SDI</i>	<i>SATA SDO</i>	GA2	<i>SATA SCL</i>	<i>SATA SL</i>	GA3
2	GND	I2C SCL	I2C SDA	GND	RSV	RSV	GND	RST#	WAKE#	GND	PE EN#	SYS EN#
1	+12V	STBY	GND	+12V	+12V	GND	+12V	+12V	GND	+12V	+12V	GND

pin positions printed white: not connected

P2 CompactPCI® Serial Peripheral Slot Backplane Connector

EKF Part #250.3.1208.20.00 • 96 pos. 12x8, 16mm Width

P2	A	B	C	D	E	F	G	H	I	J	K	L
8	GND			GND			GND			GND		
7			GND			GND			GND			GND
6	GND			GND			GND			GND		
5			GND			GND			GND			GND
4	GND			GND			GND			GND		
3			GND			GND			GND			GND
2	GND	PE TX06+	PE TX06-	GND	PE RX06+	PE RX06-	GND	PE TX07+	PE TX07-	GND	PE RX07+	PE RX07-
1	PE TX04+	PE TX04-	GND	PE RX04+	PE RX04-	GND	PE TX05+	PE TX05-	GND	PE RX05+	PE RX05-	GND

CompactPCI® Serial Backplane Connector P6 (Option)

P6 CompactPCI® Serial Peripheral Slot Backplane Connector												
EKF Part #250.3.1208.20.02 • 96 pos. 12x8, 18mm width												
P6	A	B	C	D	E	F	G	H	I	J	K	L
8	GND	8 ETH A+	8 ETH A-	GND	8 ETH B+	8 ETH B-	GND	8 ETH C+	8 ETH C-	GND	8 ETH D+	8 ETH D-
7	7 ETH A+	7 ETH A-	GND	7 ETH B+	7 ETH B-	GND	7 ETH C+	7 ETH C-	GND	7 ETH D+	7 ETH D-	GND
6	GND	6 ETH A+	6 ETH A-	GND	6 ETH B+	6 ETH B-	GND	6 ETH C+	6 ETH C-	GND	6 ETH D+	6 ETH D-
5	5 ETH A+	5 ETH A-	GND	5 ETH B+	5 ETH B-	GND	5 ETH C+	5 ETH C-	GND	5 ETH D+	5 ETH D-	GND
4	GND	4 ETH A+	4 ETH A-	GND	4 ETH B+	4 ETH B-	GND	4 ETH C+	4 ETH C-	GND	4 ETH D+	4 ETH D-
3	3 ETH A+	3 ETH A-	GND	3 ETH B+	3 ETH B-	GND	3 ETH C+	3 ETH C-	GND	3 ETH D+	3 ETH D-	GND
2	GND	2 ETH A+	2 ETH A-	GND	2 ETH B+	2 ETH B-	GND	2 ETH C+	2 ETH C-	GND	2 ETH D+	2 ETH D-
1	1 ETH A+	1 ETH A-	GND	1 ETH B+	1 ETH B-	GND	1 ETH C+	1 ETH C-	GND	1 ETH D+	1 ETH D-	GND

pin positions printed white: not connected

This connector is not populated by default. It is required together with the optional front panel Gigabit Ethernet RJ45 jack (available on request only). In rare cases this connector is provided for optimized mechanical stability (reducing effects of shock and vibration).

Ordering Information

For popular SE2-MOOD SKUs please refer to
www.ekf.com/liste/liste_21.html#SE2

Please note that the SE2-MOOD is a carrier card which typically comes without M.2 module(s) populated, unless otherwise expressly ordered. Photos shown within this document and at other places may be equipped with M.2 modules just for application demonstration. If you need a turnkey solution with M.2 NVMe and/or M.2 SATA storage modules populated, please contact sales@ekf.com before ordering.

Related Links to CompactPCI® Serial Mass Storage Solutions

SE2-MOOD Home	www.ekf.com/s/se2/se2.html
SE1-PITCH Home	www.ekf.com/s/se1/se1.html
CompactPCI® Serial PCIe Storage	www.ekf.com/s/serial.html#SE
CompactPCI® Serial SATA Storage	www.ekf.com/s/serial.html#SD
CompactPCI® Serial SAS Storage	www.ekf.com/s/serial.html#SS

Related Documents CompactPCI® Serial

Basics / Overview CompactPCI® Serial	www.ekf.com/s/smart_solution.pdf
CompactPCI® Serial Home	www.ekf.com/s/serial.html

Recommended CPU Cards

SC2-PRESTO	www.ekf.com/s/sc2/sc2.html
SC3-ALLEGRO	www.ekf.com/s/sc3/sc3.html

Beyond All Limits: EKF High Performance Embedded

Industrial Computers Made in Germany
boards. systems. solutions.

EKF Elektronik GmbH
Philipp-Reis-Str. 4 (Haus 1)
Lilienthalstr. 2 (Haus 2)
59065 HAMM
Germany



Phone +49 (0)2381/6890-0
Fax +49 (0)2381/6890-90
Internet www.ekf.com
E-Mail sales@ekf.com